



CROSS TALK

► **WAR** . . . While we do our work in comparative comfort and in comparative freedom from fear, other young men in Europe are shooting each other in the stomach, inflicting unmentionable agonies of body and spirit upon each other and upon their families. They are remaking the boundaries of Europe. And if you are young enough and wish to shoot somebody in the stomach listen to the sentimentalists in this country and to the speculators. But if you don't look upon this stomach-shooting business with any degree of pleasure, make up your mind to be as hard and realistic as possible. What will a war get you and me?

Make up your mind that the sentimentalists will not appeal to our reason, they will work on our emotions for, like the author of "Mein Kampf" (which you had better read) they have discovered that emotions and not reason rule the people.

A war will get us, if we die, glory and peace and a name carved upon stone in a shrine dedicated to those who fell in a mad delusion; if we live a war will get us debts and disappointment and utter disillusionment—another generation wasted. Our children may survive to see the honest clean world of tomorrow—but we won't.

► **HMMM!** . . . John E. Otterson, former president of Winchester Repeating Arms Corp., ERPI, and Paramount pictures now heads Radio Wire Television Corp. of America, an affiliation of Wholesale Radio Service, Wire Broadcasting, Inc., and several other companies manufacturing communication products and distributing programs by wire.

In accepting active leadership of this new enterprise, Mr. Otterson said. "Every current technological trend points to the ultimate distribution of

entertainment by wire. Particularly is this true in the case of television where, according to leading scientific authorities, the transmission of images beyond the horizon presents great difficulty. Not only can wire networks bring radio and television into any home in America from a central point, but this can be achieved without interference by static or other forms of atmospheric disturbance."

► **REVOLUTION** . . . Under this title, *Fortune* in its September issue, tells the lay public what readers of *Electronics* must have gleaned if they have read its pages carefully during the past several years—that frequency modulation threatens a revolution in broadcasting. Within a month or two there has been a remarkable stampede among broadcasters to get in on this static-free method of transmission. *Fortune* tells of Major Armstrong's efforts, largely unsuccessful, to get the industry behind his work; tells the public of the remarkable lethargy of the industry in failing to grasp the fundamental differences and advantages of FM over amplitude modulation (AM). The radio industry cries for change and new things, but only for little changes—nothing really fundamental. Industry only wants a new type of dial, or a 12 inch speaker in place of an 8 inch speaker—nothing like a whole new set-up that might banish noise and produce out of the air honest-to-God tone fidelity.

But industry had better look up. Long ago, when pentode tubes first threw a jolt into complacent radio receiver manufacturers, the statement was made "by pulling down the shades, you can sleep late in the morning, but you can't keep the sun from coming up." The sun of frequency modulation is surely coming up. Experiments by

the General Electric engineers and by those of the Yankee Network demonstrate conclusively this fact.

► **JITTERS** . . . Youthful dancers are not the only ones today who have developed a language of the jitters. Two young engineers taking the training course at General Electric were overheard to say "Put a tac on that BTA and, after you've hooked up the pots and c-t's and plugged power, see if she still swings and hunts."

In case you really want to know what this gibberish means, here it is. "Attach a tachometer to that variable-speed alternating-current motor and after you have connected the potential and current transformers and then made the proper electrical connections at the switchboard, start the machine and find out if the speed still oscillates about the point of synchronism."

► **FRESH START** . . . Two of our old friends are making fresh starts in the world, one by leaving the radio industry, and the other by striking out for himself. Austin Armer, genial engineer-salesman for Magnavox, joins the staff of the University of California on a project involving the development of field machinery for the beet sugar industry.

Frank H. Shepard, Jr., who has the most uncanny way of making electron tubes do useful things has left RCA and gone into business for himself. He can be located at Merchantville, N. J., and if you have a problem that might be solved by an amplifier, or a phototube, or just by sheer knowledge of circuits and parts, he merits a call. Shepard is unconventional in the manner in which he puts tubes to work and often utilizes little known characteristics of conventional circuits for a useful purpose.

DIELECTRIC CLOTH . . . Better coils in smaller space are possible with the new glass fabric insulation, as Reuben Lee shows in his article on page 33



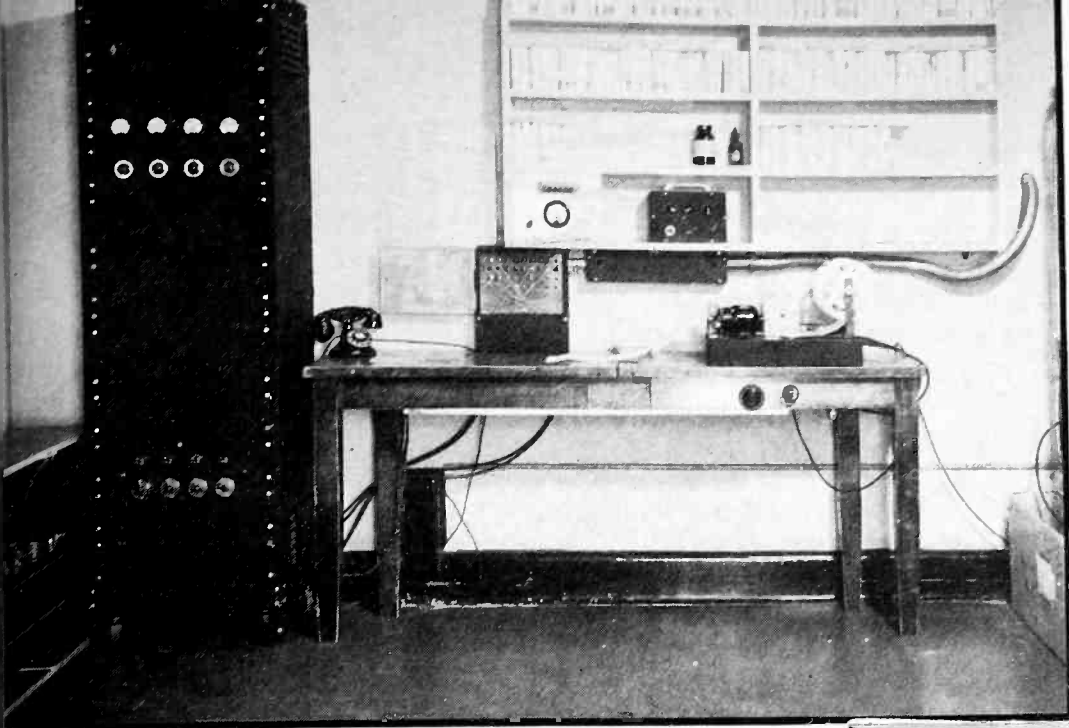

Left, the complete amplifying and recording system. Response flat between 1 and 45 cps, and sensitivity better than 10 microvolts

Below, the recording unit, which uses a loud-speaker voice coil and lever system to trace the output variations in ink on the moving paper strip

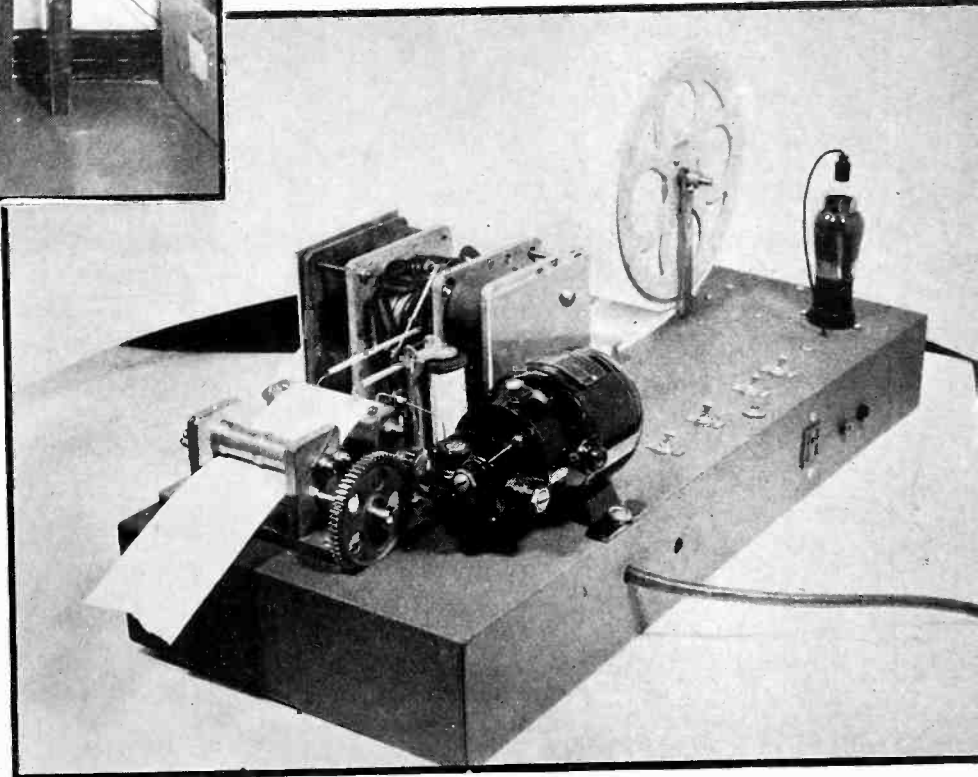

A New Bio-Electronic Application

ELECTROENCEPHALOGRAPHY

FOLLOWING the discovery of so-called "animal" electricity by Galvani in the 18th century, the electrical activity of living material has been studied wherever evidence of its existence could be found. Electrodes have been applied to almost every portion of the human body and to laboratory animals with a view to finding new sources of potentials of this type. The results of researches of this type have yielded an immense body of information, much of which it is still impossible to evaluate at the present time. From this mass of information was evolved the valuable and well known technique of electrocardiography or the science of tapping the electrical action currents of the heart by means of electrodes placed on the surface of the body.

Since the human body is in reality

By **WALTER E. RAHM, JR.**

New York State Psychiatric Institute

a complex matrix composed of individual cells and since these cells are filled with electrolytic solutions, it is an excellent conductor of electric current. Therefore, it is possible to study the electrical activity of underlying structures by means of electrodes placed some distance away on the body surface.

Hans Berger spent more than ten years studying electrical action potentials which he obtained by placing electrodes upon the scalp of human subjects. When, after these many years of painstaking research, he was convinced that these potentials had their origin in the brain

tissue, he published a paper in 1929 announcing his findings. For several years following this he published further reports of his findings only to have them ignored or dismissed as representing nothing but artifacts. Critical examinations of his work by others—notably by Adrian, Nobel laureate in physiology—lead to a complete vindication of his results. Since then work along these lines has developed at a continuously accelerating pace.

As a consequence of intensive investigation it is now known that the electrical currents occurring in the brain are considerably more complicated than was first supposed. Certain potentials are now recognized as being associated with specific types of disorders of the central nervous system. It is now known that the spike and dome pattern

occurs frequently in epilepsy and the slow so-called "delta waves" often appear over the site of a brain tumor. Yet despite intensive research this field of investigation remains still relatively untouched. Figure 1 shows some normal and abnormal brain wave potentials.

Amplifier Design Problems

This article deals with some of the problems and demands made upon electronic technique in the endeavor to construct equipment suitable for this specialized type of research. At first glance the problem of amplifier design for this purpose may seem prosaic, but upon closer study the need for an unusual design is apparent. The frequency response curve of the amplifier must be flat from 1-45 cps, which band width represents the frequency spectrum

served to eliminate this type of interference.

Keeping all these considerations in mind, an amplifier was designed to be push-pull throughout. This type of design immediately insured the independence of the input stages, a fact which may be easily demonstrated. It is possible to record simultaneously with one amplifier the electrocardiogram (normally about one millivolt in amplitude) and with another amplifier the electroencephalogram (normally about 50 microvolts in amplitude). There is no cross-talk despite the amplitude differences. If however this is attempted with single-ended amplifiers the electrocardiogram will appear also in the electroencephalogram and distort the record beyond all usefulness. There are of course no electrocardiographic currents normally detectable in the head but

satisfactory since they greatly reduce the physical dimensions of the equipment and also permit all connections to be made below the chassis. Since a large proportion of undesirable interference appears as potentials in-phase across the input grids, it is desirable to reject all in-phase potentials. For this reason none of the cathode resistors are by-passed. In addition a certain amount of feedback, which discriminates against the in-phase potentials, is obtained by the circuit in Fig. 2. In-phase potentials increase the total current flow through the cathode resistor of the second stage. The voltage thus generated by this increased current flow is 180 degrees out of phase with the in-phase potentials on the input grids. Therefore the grid resistors of the first stage are returned to the cathode of the second stage rather than to ground as is customary. Despite the fact that the first three stages are battery operated, the total current drain on the plate supply batteries is only 0.8 ma thus making possible the use of small B batteries with a consequent saving in space. In the face of so light a current drain the useful life of the batteries is approximately eight months.

Inasmuch as the problem of 60 cycle interference from strong magnetic fields is a particularly acute problem in our location, resonant filter circuits have been installed across the grids of the output stage. With this circuit, Fig. 3, the frequency response curve of the amplifier is flat to 45 cps but is down 30 db at 60 cps.

Recording System

While the amplifier design embodies some novel features it is essentially straightforward throughout. The recording system however is completely new and represents a special development for this particular problem. Formerly either a cathode-ray tube, string galvanometer or mirror oscilloscope was used in conjunction with photographic recording. This method is open to many objections other than the technical difficulties involved. First, it is often necessary to record for long periods of time for which photographic methods of recording are prohibitively expensive. Secondly for long records it is almost impossible for the average research

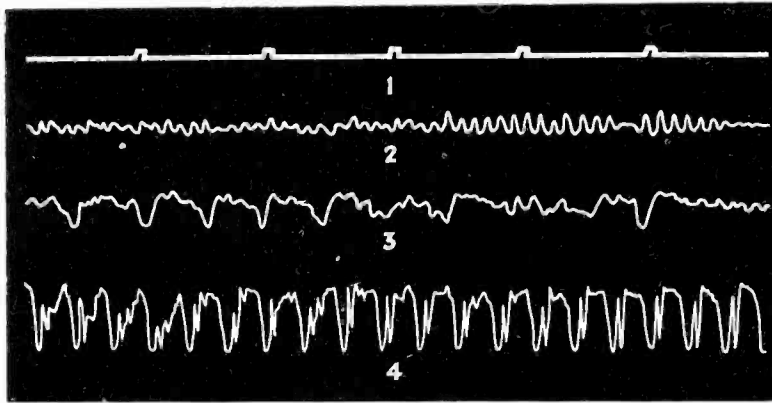

Fig. 1—Typical brain wave potentials. (1) One second interval markers, (2) normal or alpha wave, (3) wave over a brain tumor and (4) during an epileptic attack

of brain wave potentials. This unusually low frequency response necessitates a time constant of at least 0.5 second. In view of the amplitude of brain potentials it is highly desirable that the noise level of the amplifier be not greater than 2.0 microvolts. Since as many as four amplifiers may be used simultaneously recording from eight electrodes it is absolutely essential that the input circuits of these amplifiers be independent. For this reason the use of a single-ended amplifier design is undesirable since the coupling occurring by virtue of a common ground effectively connects half of the electrodes in use together. Finally the high gain of the amplifiers, the intensity of 60 cycle fields in most buildings, and the nearness of the 60 cycle frequency to that of the brain waves creates a special problem in this respect. Unusual and extreme precautions must be ob-

their apparent presence is an artifact produced by coupling through a common ground. It is apparent therefore that if regional differences over the surface of the head are to be studied, independence of input circuits is essential.

To keep the noise level low it was found desirable to use precision wire wound resistors in the input stage. Likewise a good grade of oil-filled coupling condensers reduced leakage to a minimum. The value of the plate resistors in the first stage is rather critical with respect to noise and should be kept as low as feasible. Since the first three stages are battery operated from a common source it is desirable to keep the plate voltage on the first stage low not only to reduce the noise level, but also to prevent instability.

Tubes chosen for this design were 6Y7G medium- μ dual triodes. These tubes have been found very

laboratory to develop the film or paper obtained. Thirdly, one cannot see at the time of recording what is being recorded so that much film or paper is wasted on useless artifacts. The recorders described here produce an inkwritten record on inexpensive syphon recording paper. Several factors were taken into consideration in the design of these

gradually to zero at 100 cps. When in use with the amplifier at full gain a maximum sensitivity of 2.0 microvolts per millimeter can be obtained. The output stage consists of a pair of 2A3s coupled directly to the inkwriter. No coupling transformer is used because of core saturation at these low frequencies and consequent discrimination against the lows. The

output tubes may be balanced. The plate-to-plate d-c reading should be zero, otherwise the base line will be shifted by the d-c component.

The person from whom a record is being taken is placed in a completely shielded room. The electrodes used are small flat discs of solder approximately one-quarter of an inch in diameter and one-eighth of an inch thick, recessed on one side to retain a small amount of electrode jelly. They are held on the scalp by means of collodion. No hair need be removed to make good contact. A piece of No. 28 enameled wire, embedded in the solder button, is connected to the input panel. Separately shielded wires from this panel run to a switchboard where the operator may connect any electrodes to any amplifier. The switchboard is capable of handling eighteen electrodes at one time.

The present set-up provides a method of obtaining an inkwritten record of alternating potentials, with

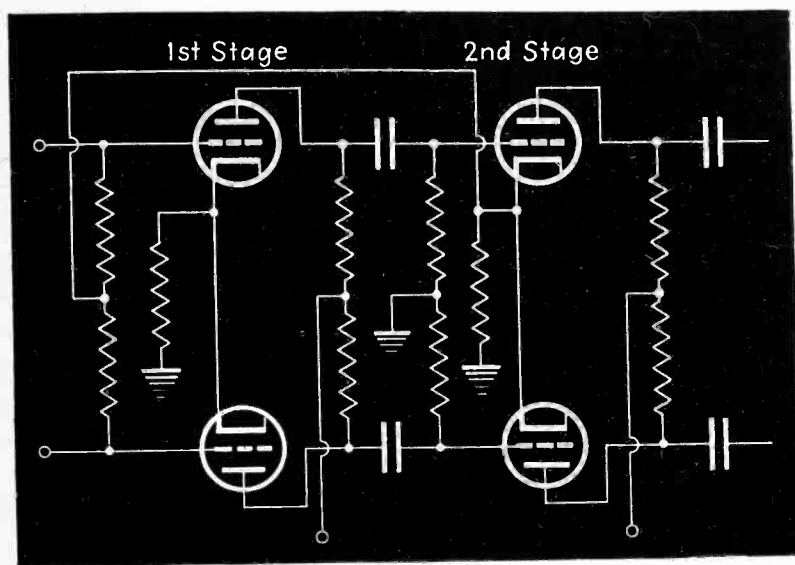
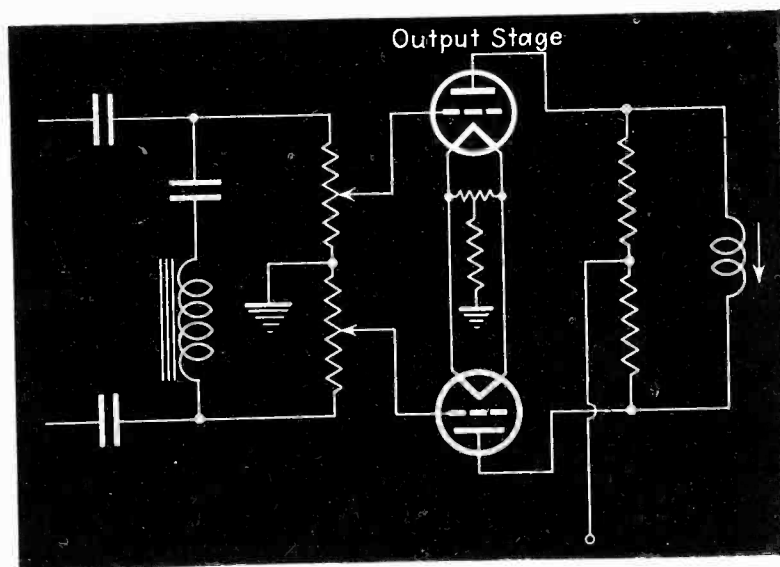

Fig. 2—In order to aid in rejecting in-phase interfering potentials, the feedback connection shown above is employed

Fig. 3—Resonant filters tuned to 60 cps are employed in the grid of the output stage to reduce the effect of 60-cps stray fields

writers. No mechanical or electrical resonance should occur within the 1-45 cps band. In addition a fairly large tracing should be obtained and the relationship between the impressed voltage and the pen displacement should be linear. Since no commercial units were available which were satisfactory for this purpose, the problem of construction was laid at our own doorstep. A writer was constructed using a permanent field magnet, a 300-ohm voice coil and a simple lever system having an amplification factor of seven. So that a reasonably large tracing could be obtained, the spider supporting the voice coil was made quite flexible. It must not however be too flexible or a severe resonant period will appear within the 45 cps band. The amplifying lever is merely a piece of stainless steel hypodermic tubing carried in a simple C type pivot bearing. The end of the hypo tubing merely dips into the inkwell, the capillary action of the tubing actually feeding the ink. The long arm of the lever is braced to prevent the pen from whipping. The writer is linear for 1 cm each side of the base line and the frequency response curve is flat from 1-50 cps tapering



power loss sustained by this impedance mismatch is considerable, but is more desirable than frequency discrimination. Triodes are very desirable as output tubes since very little distortion occurs despite the mismatched impedance. Pentodes have been used with the hope of increasing the pen displacement but distortion was so severe as to render their use undesirable. It may be also well to mention that the plate load resistor in the output stage be variable so that any inequalities in the

a flat frequency response range of 1-45 cps, with a maximum sensitivity of 2 microvolts per millimeter. With an output stage compensated for the loss in inkwriter sensitivity it should be possible to extend the frequency range to 90 cps. In the present design however the bandwidth has been restricted to 45 cps since no brain waves of higher frequency have been reliably reported. The restricted bandwidth also reduces the noise level and markedly reduces 60 cycle pick-up.

I.R.E. Convention, 1939

Twenty-eight papers ranging from shaping of cable signals to administering a radio manufacturing plant, with special attention to television, u-h-f's, and aircraft radio, were presented at the I. R. E. Annual Meeting in New York last month

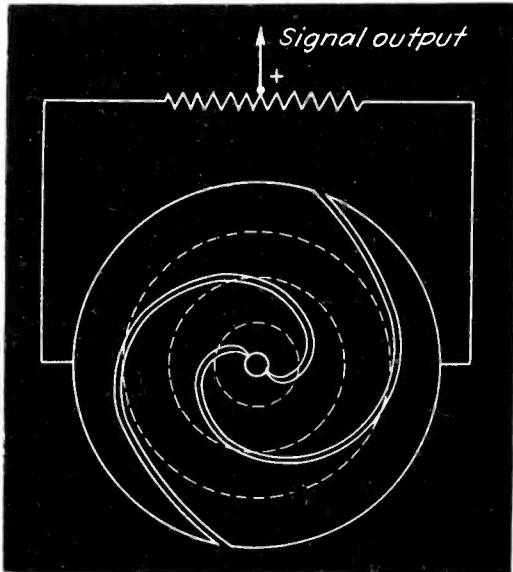

Target of R. E. Shelby's cathode-ray frequency modulator

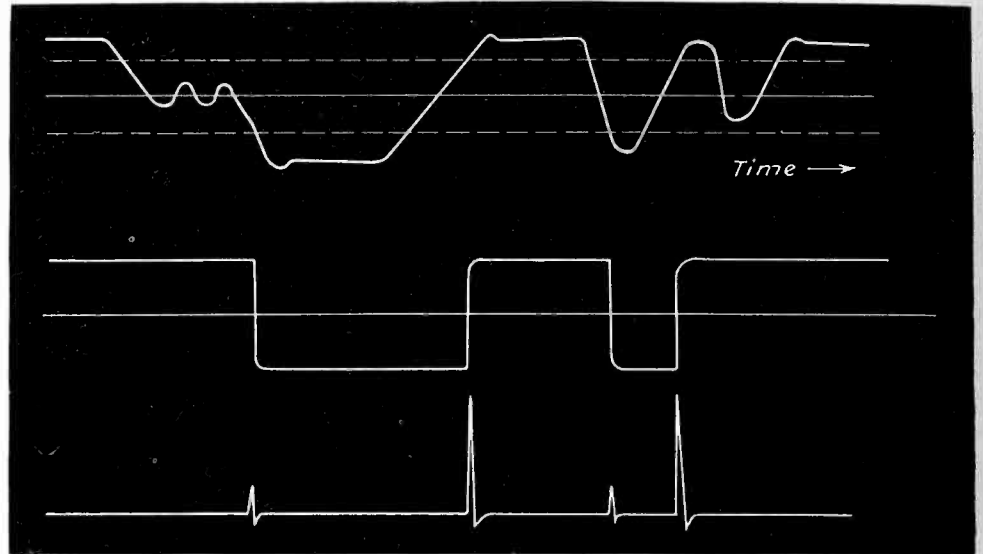

Received cable signal (top) and shaped version (center) produced by a thyatron inverter circuit (Haglund and Breyfogel)

AIRCRAFT radio equipment and radio economics emerged as topics of major interest in the 14th Annual I.R.E. Convention held in New York, September 20-23, at the Hotel Pennsylvania. In all, 28 papers were delivered covering not only such well established items as television and u-h-f technique, but also the application of thyratrons to the shaping of cable signals and the engineering administration of a small radio manufacturing plant. The attendance was 1612, about 100 less than last year, but a very healthy turnout nonetheless. In addition to the technical papers, presentations were made to Sir George Lee (the Institute Medal of Honor) and to H. T. Friis (the Liebmann Memorial Prize).

Applications of Electronic Techniques

Papers which illustrated the application of electronic techniques to radio engineering advancement were plentiful. One of the most interesting was that delivered by R. E. Shelby of the National Broadcasting Company, who described a "Cathode-Ray Frequency Modulation Genera-

tor." This is a cathode-ray device intended to produce frequency-modulated signals by generated square waves whose phase depends on the audio modulating voltage applied to the tube. Phase angles in excess of 360 degrees may be generated, whereas the more usual method (that employed by Major Armstrong) is limited to an initial phase displacement of about 30 degrees. To obtain wide-band frequency modulation from such a small phase displacement requires the use of many frequency multiplications, with attendant tubes and power sup-

plies. By making possible a wider phase angle swing, Mr. Shelby's device reduces the frequency multiplication required, and hence makes possible a simpler transmitting system.

The principle of the cathode-ray generator is shown in the accompanying illustration. The spiral segments shown constitute the target of a cathode-ray tube. The dotted circular lines indicate the path taken by the cathode-ray beam which scans the target in a circular fashion. Circular scanning is accomplished by applying equal alternating voltages

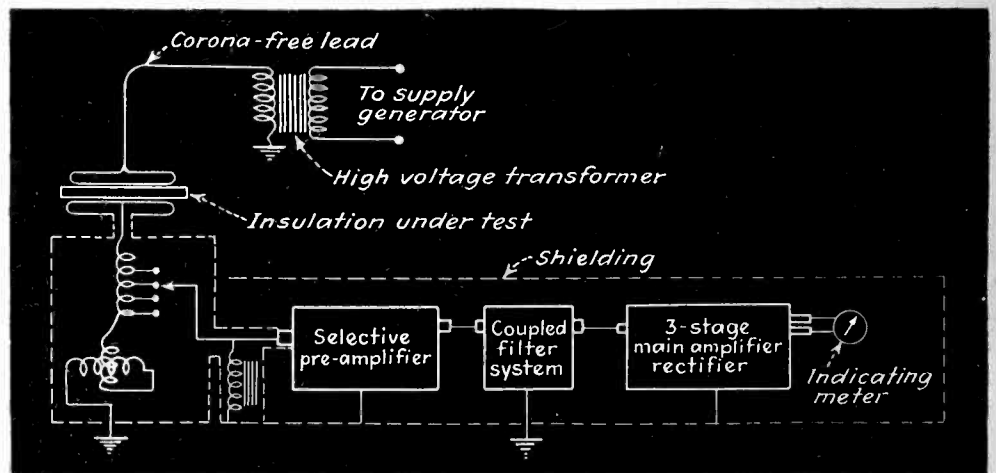

Sensitive bridge circuit for detecting ionization at 60 cps in voids within insulation, described by H. A. Brown

0 degrees out of phase to the two sets of deflection plates. The absolute amplitude of these deflection voltages is controlled by the audio-frequency signal whereas the frequency is kept constant. Consequently, the diameter of the circular scanning path varies with the audio frequency signal. As the scanning beam passes over the two spiral segments it generates in the output resistance a square wave of constant

frequency, but of a phase depending on the diameter of the scanning path. By the use of spiral segments which have many turns around the center, it is possible to produce phase changes of many hundreds of degrees. Subsequent frequency multiplication will produce wide-band frequency modulation, provided that the initial audio circuit displays a gain inversely proportional to frequency. The device has been tested

in a frequency-modulation transmitter which operated from the Empire State Building and has proved entirely satisfactory.

The investigation of ionization and corona discharge in insulators was discussed by H. A. Brown of the University of Illinois. This is a topic of increasing interest because of the greater demands put on insulation especially at high frequencies. Bridge circuits for detecting internal ionization in voids within insulators, both at 60 cps and at high frequencies were shown. The 60-cps bridge, shown in the accompanying illustration, makes use of a high gain amplifier and selective filter circuit to detect the presence of internal ionization.

Still another unusual electronic application was that of shaping cable signals by means of thyatron inverter circuits, described by H. H. Haglund and A. W. Breyfogel of Western Union. Waveform variations introduced by the cable inductance and capacitance, together with slow variation of the d-c axis due to earth currents induced in the cable, make it necessary to shape cable signals before using them to actuate the recorders. The shaping process irons out the unwanted variations and produces an essentially square-wave signal, the beginning and end of each square being determined by some outstanding characteristic of the signal as received from the cable. In prior practice it has been customary to use repeating relays of the electro-mechanical type to perform this shaping function, but the introduction of higher keying speeds has pushed cable operation to the "ceiling of capacity" and hence a more flexible and reliable relaying system has been made necessary. A typical example of the signal received from the cable is shown. The dotted lines represent the d-c level at which the grid circuits of two thyratrons are set. The thyratrons are arranged in an inverter circuit, so that only one of the pair of tubes will fire when the level indicated by the dotted lines is reached. When this tube does fire, an impulse travels from this tube to the other, thus putting the second tube in readiness to fire. In this way the tubes work alternately. The current flowing in the plate circuits of the tube is the square wave desired.

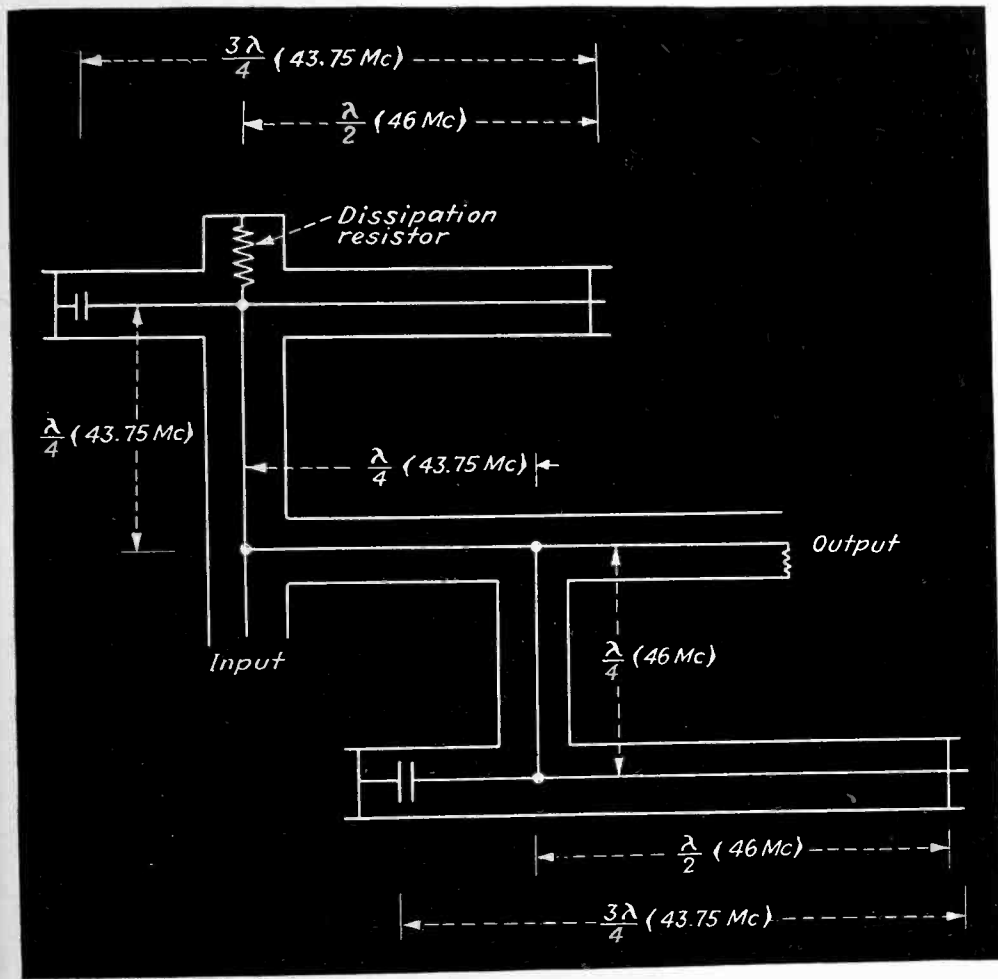

A coaxial "notching" filter structure, designed by G. H. Brown, used in single-sideband television transmissions

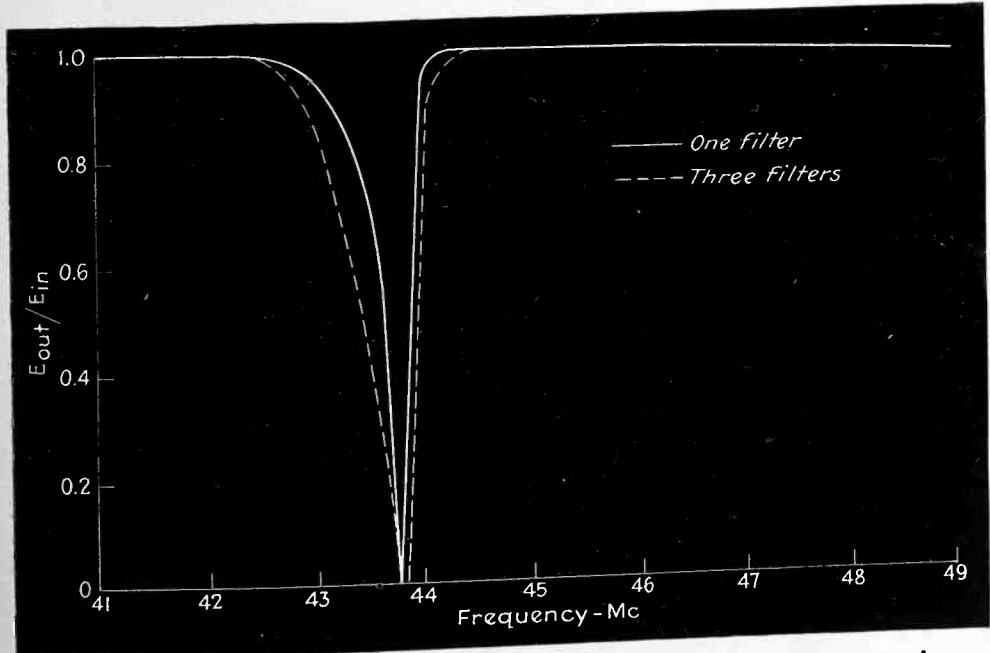

Attenuation characteristic of the filter structure shown above, designed to protect the adjacent channel

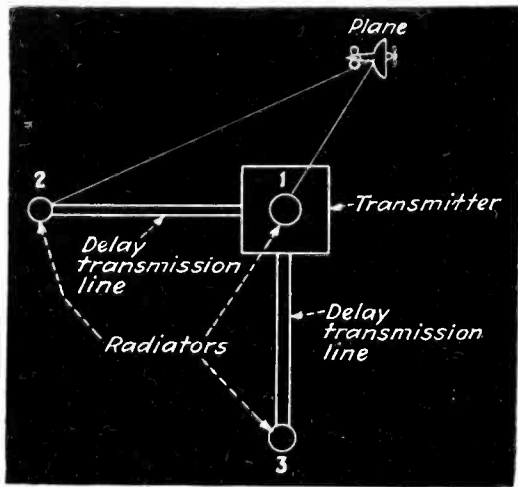

Frequency-modulated omni-directional beacon (E. N. Dingley)

It will be noted that a change in the square wave current occurs only when the dotted line, on the opposite side of the axis, is exceeded by the signal wave. The impulses which travel from tube to tube are shown on the same time scale at the bottom of the diagram.

Plumbing for Filters

Since television transmissions went single sideband (quasi-vestigial-sesqui-single sideband by actual count), it has been the job of engineers to devise filters to eliminate the undesired portion of the unwanted sideband. Since the carrier frequencies are high and the impedances low, lumped-constant filter elements are impractical for high-level operation. In consequence, coaxial line segments have been employed to produce the required filter structure. Dr. G. H. Brown of RCA delivered a paper on this general subject, and outlined the methods of simulating capacitances and inductances by coaxial segments. A typical "notching" filter designed by Dr. Brown is shown. This is intended to produce very high attenuation at the frequency of the sound carrier of the adjacent television channel. In practice, three such structures are employed to obtain the desired attenuation. The vestigial sideband filter proper was described in the March 1939 issue of *Electronics*, pages 26 and 27.

Among the other papers on television was "Transient Response in Television" by H. E. Kallman, R. E. Spencer and S. P. Singer, of E.M.I. in England. This paper was an exhaustive treatment of the response

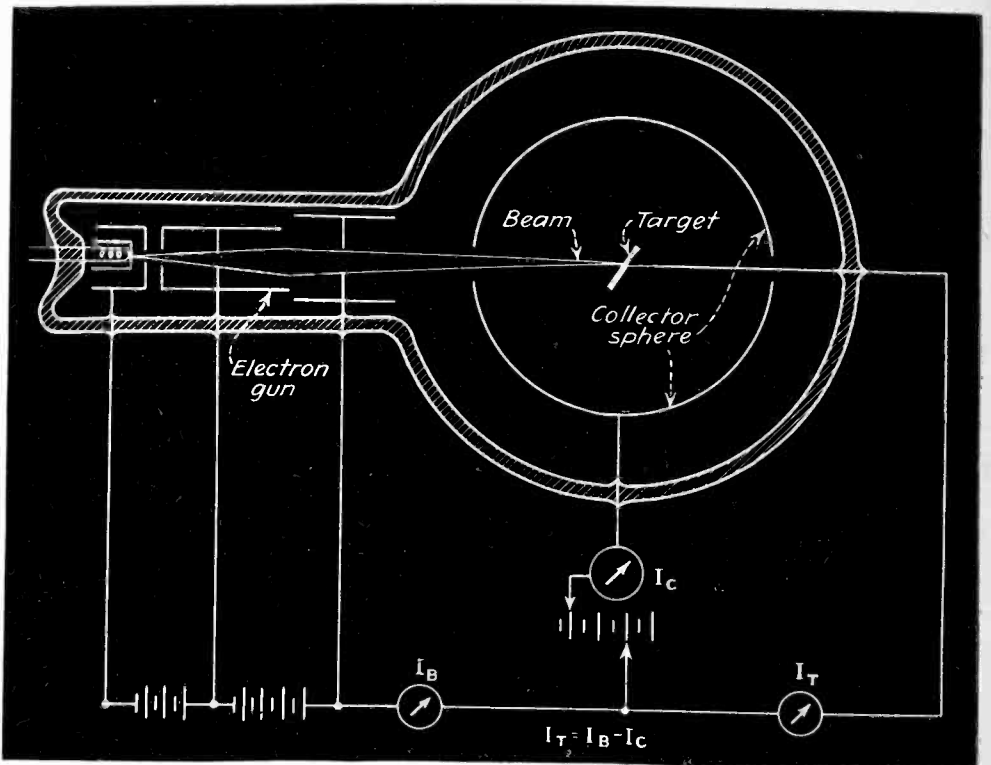

Tube for studying effects of secondary emission on various surfaces, described by I. G. Maloff. Electrons liberated from the target are collected by the surrounding sphere

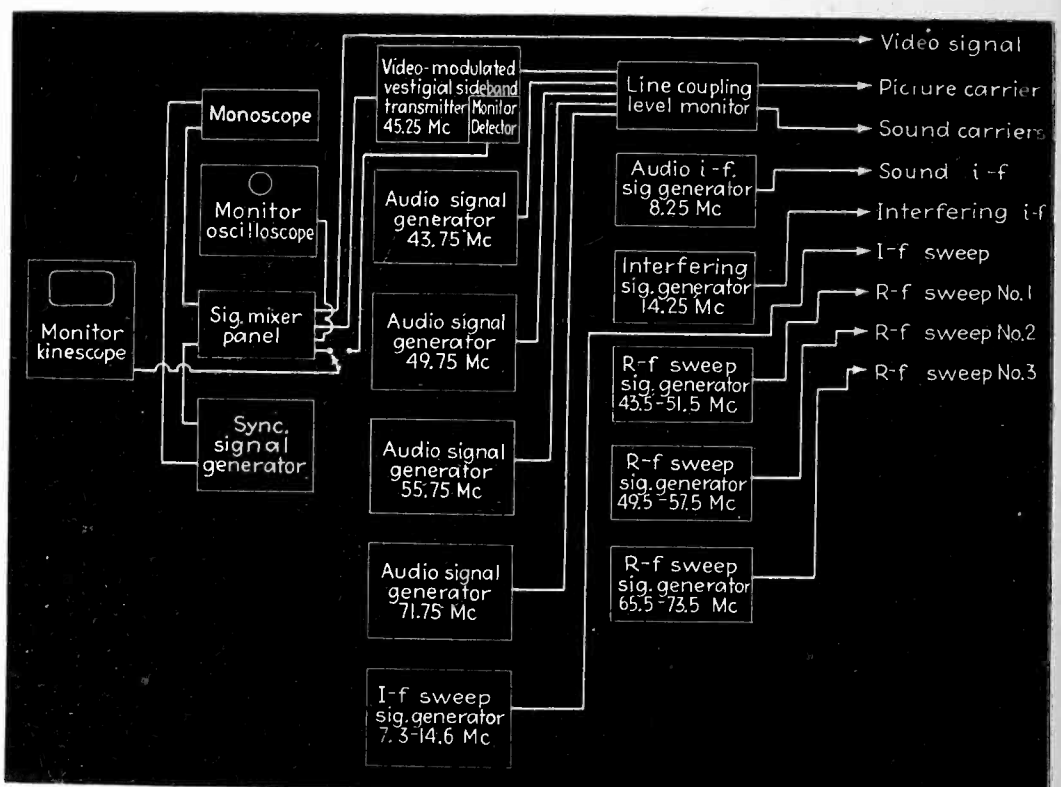

Television test equipment used in the General Electric factory at Bridgeport, Conn., for aligning and testing production receivers, described by L. J. Hartley

of television amplifiers to a unit pulse of voltage. The authors showed that the simple shunt peaking coil employed in video amplifiers is very nearly as high in performance as more complicated filter structures. A figure of merit for transient response was set up which takes into account the rate of rise of the response voltage, and the amount of overshoot. The figure was applied to a very wide variety of coupling

filters, under double-sideband as well as sesqui-sideband conditions. From the discussion it was apparent that this paper was a very significant compilation of information on an outstanding topic in modern television development.

I. G. Maloff of RCA gave his paper "Functions of Electron Bombardment in Television" for the second time (having presented it at the West Coast Convention earlier

this year). The effect of secondary electrons in the redistribution of potential within television pick-up tubes (see "The Orthicon" page 9, July 1939 *Electronics*) and in the operation of picture tubes was discussed from a quantitative as well as general point of view. One of the methods of measuring the secondary electron emission properties of surfaces was that shown in the accompanying illustration. A target surrounded by a spherical collector anode is subject to bombardment by a beam of electrons which enters through an aperture in the side of the sphere. By measuring the current to or from the target, relative

to the current collected and the current from the electron gun, it is possible to determine the ratio of secondaries to primaries at different values of accelerating voltage and retarding potentials. This work has been of value in establishing the potentials reached by insulated targets under electron bombardment, a topic of great importance in the design and operation of storage television pick-up tubes.

Still another paper on television was that by E. W. Herold of RCA Radiotron, who outlined an analysis of the relative merits of different types of converter tubes for television service, with respect to the

noise introduced by them. The conclusion was that a pentode type converter with control-grid injection was the best, a triode nearly as good, and the hexode definitely inferior. Mr. Herold showed that the noise introduced by an r-f amplifier of the 1852 type is very nearly the same as that introduced by a pentode converter of the same type, and hence that there is no advantage of using an r-f stage, so far as noise considerations are concerned. The effects of fixed vs. grid-leak bias seemed definitely to give the edge to the latter method. A grid leak of 4 megohms was recommended for the latter circuit.

One of the first papers on television receiver manufacturing practice delivered in this country was that by L. J. Hartley of the General Electric Bridgeport works, who spoke on "Production Alignment Apparatus for Television Receivers." The equipment used at Bridgeport for this purpose is shown diagrammatically in the figure. A static-image monoscope tube is used as the signal source. This signal is mixed with the sync signal, monitored both oscillographically and by viewing the image, and then transferred to the signal generator proper which produces a 4 watt signal with sesqui-sideband at a carrier of 45.25 Mc. This is the only channel which at present is tested on an image basis. However, the audio channels on 49.75, 55.75 and 71.75 Mc are tested directly with tone, and the interfering channel on 43.75 Mc is also tested. These four audio generators are mixed with the picture signal in resistance pads and fed out over a single coaxial cable.

For non-image testing two carrier generators and four sweep signal oscillators are available. The sound i-f is tested at 8.25 Mc and also on the interfering i-f frequency of 14.25 Mc. An i-f sweep covering the range from 7.3 to 14.6 Mc is used to line up the picture and sound i-f channels. R-f sweeps for three channels, covering each channel with 0.5 Mc and 1.5 Mc overlap at the lower and upper edges of each channel, are used for overall check on circuit alignment. The sweep generators are built with motor-driven tuning capacitors so cut as to allow using sinusoidal sweeps in the alignment

(Continued on page 70)

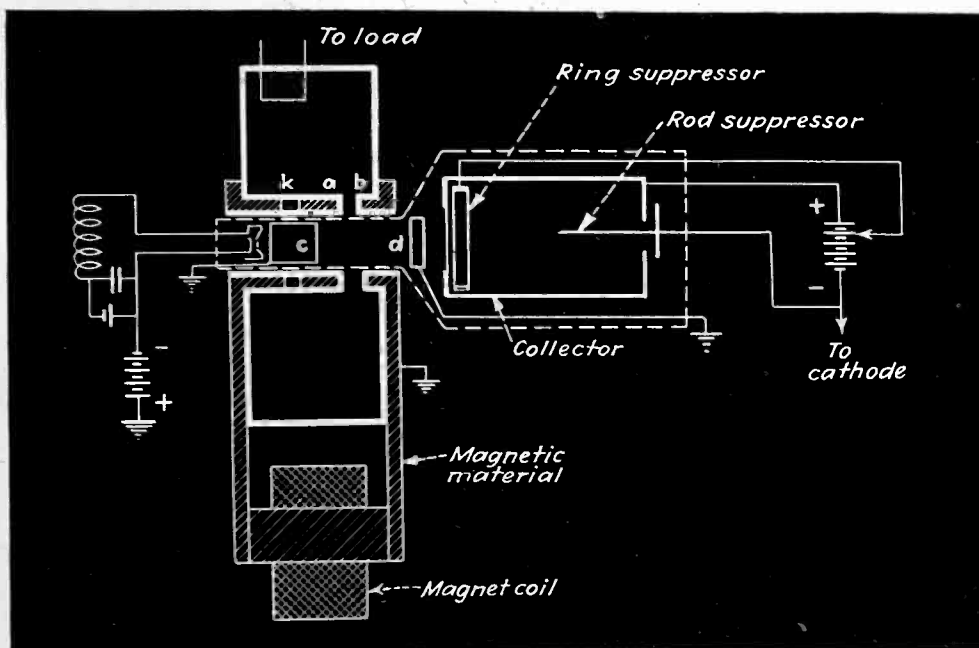

The inductive-output high frequency amplifier (Haeff and Nergaard). Ten watts at 500 Mc over a 10 Mc band have been produced by this structure

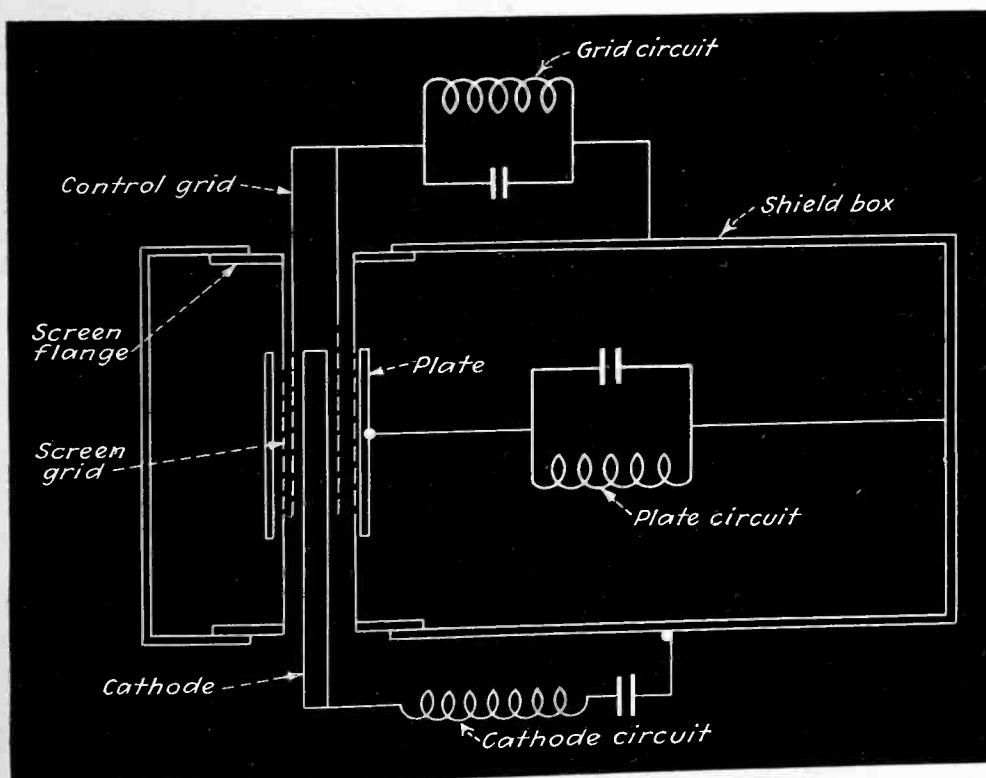

Another approach to the u-h-f problem, the basic circuit structure of the 20-kw tetrode. A pair of these tubes has generated 56 kilowatts in the u-h-f region with over 50 per cent efficiency

Below, right, Radio Officer C. H. Roberts seated at the operating position. Before him, left to right, are the r-f preselector unit of the receiver, the receiver proper, and the remote control equipment for controlling the transmitter. Below, left, a close-up view of the transmitter remote control, consisting of cam segments (left) which come to rest against the stop when the proper frequency has been found

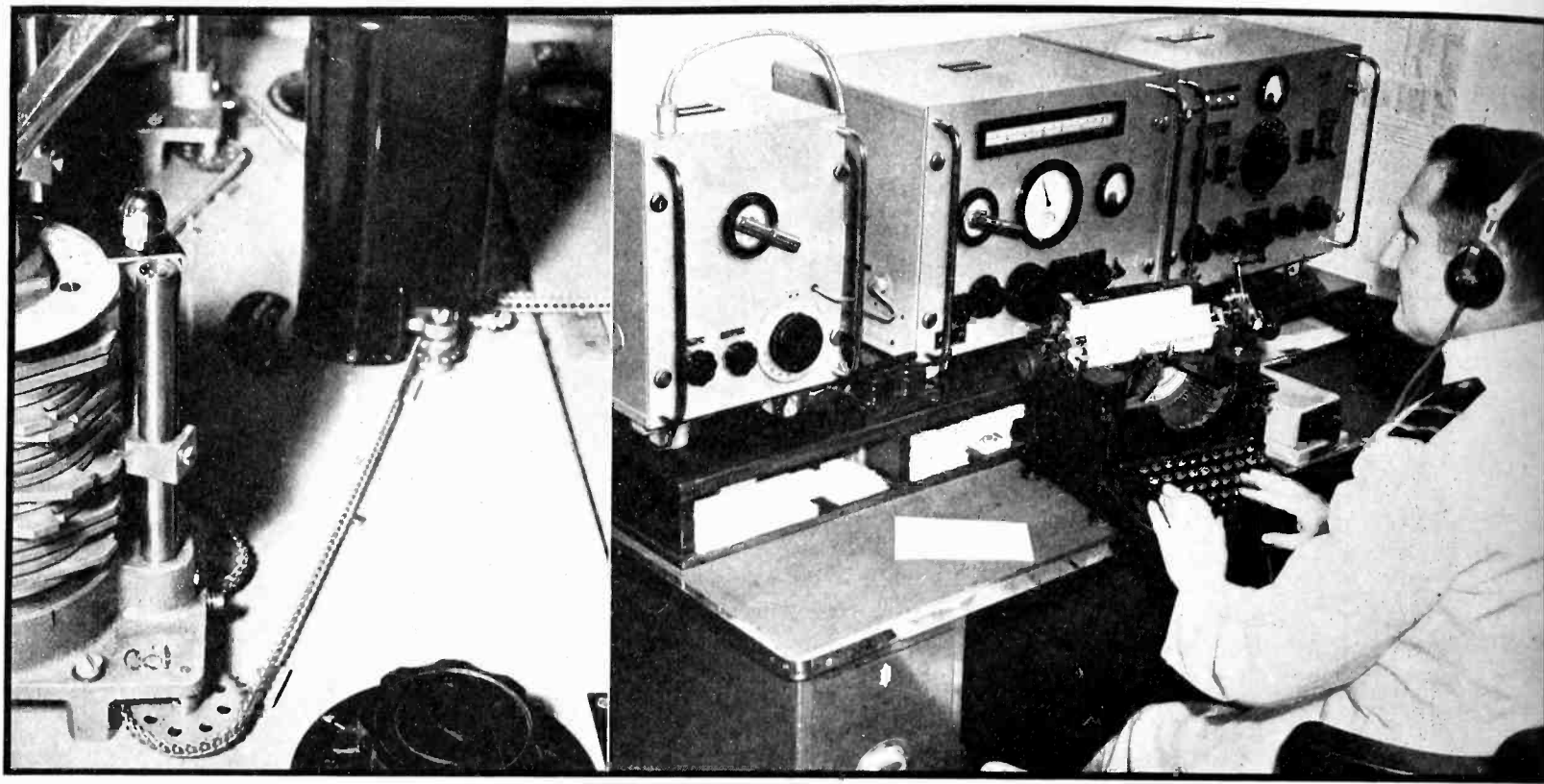

RADIO MAURETANIA

With larger ships ruled off the sea, the new Mauretania continues her transatlantic runs against the hazards of war. Her radio equipment, shown here, is the latest on the sea

The Bellini-Tossi direction finding loop system. The loops are fixed in position, the bearing being indicated electrically. The loop parallel to the keel is smaller because of reradiation from the hull

The pre-selector, receiver and remote control units open for inspection. Bands are switched by rotating the drums until contact is made with the desired coil terminals

The "iron-man" of the installation is the automatic remote control of the transmitter (right of center). The arms extending from the control unit tune the circuits in the transmitter proper

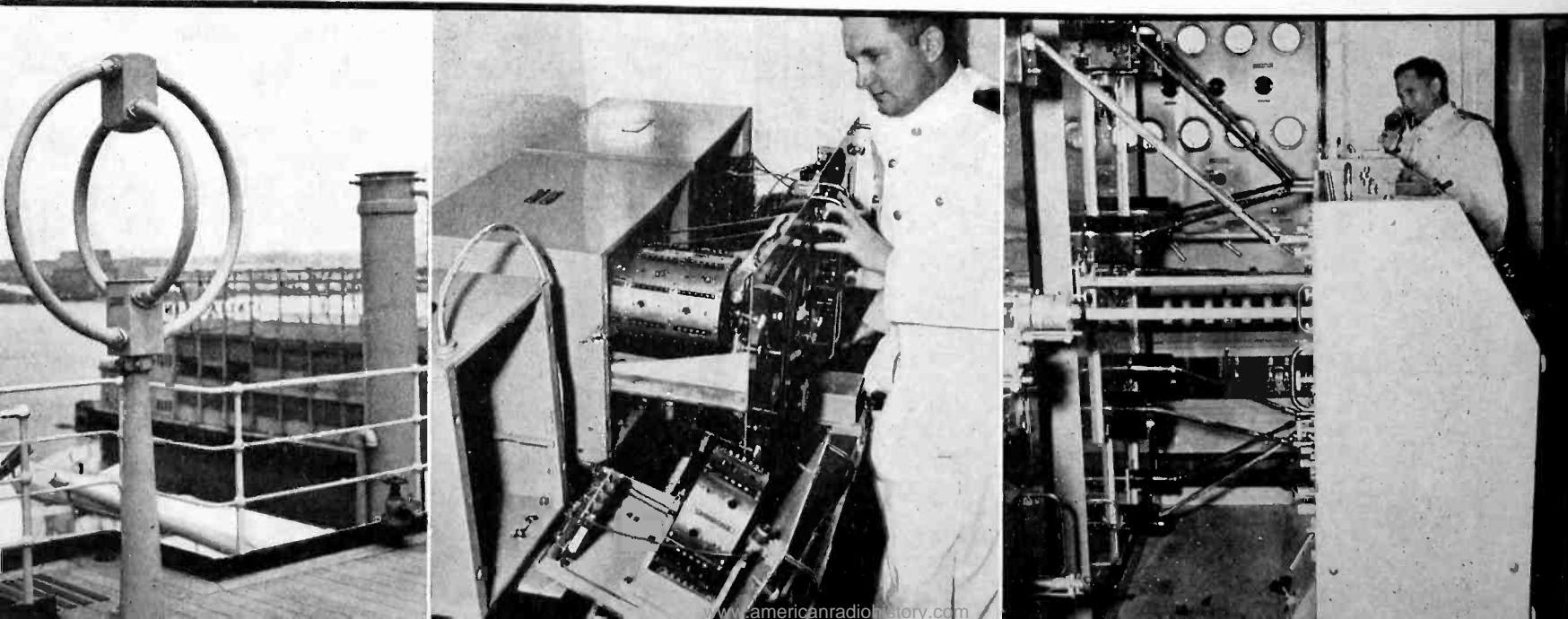

A Special-Events Transmitter

For broadcast use in picking up outside special events, this 15-watt storage-battery-operated equipment is readily portable, and should offer no difficulties to station engineers desiring to construct it

By D. F. LANGHAM

Engineering Dept., WFBL

CORRELATION of the ultra high frequencies with special events has long been taken for granted. Most of the pick-ups for rebroadcasts of short range mobile programs have utilized frequencies above 30 megacycles. The modern trend, however, seems to indicate increasing interest in the possibilities of the intermediate frequencies for this purpose, as for instance, golf course coverage.

This trend may be ascribed to the many factors affecting transmission at ultra-high frequencies which frequently vary with environment. No one can be sure of the signal propagation over land because of the presence of "shadow effects." Usually the amount of power used is neces-

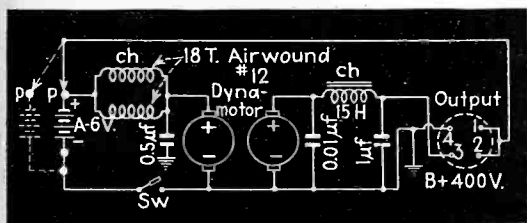

Dynamotor power supply circuit, showing r-f and a-f filters

sarily limited to a very few watts since the majority of such transmitters are of the battery operated, pack type. Among other drawbacks is the ever present bugaboo, ignition interference, which is always bad enough in spite of "squelch" circuits.

These considerations, among others, led to the decision to give the intermediate frequencies a trial, frequencies which at WFBL are allocated from approximately 1.6 to 2.8 Mc. A compromise was found between power and portability, in a unit which would fit into the dimensions of a small suitcase. The power

supply unit is housed separately in a similar case.

Selection of the dynamotor power supply was a matter of elimination since batteries were impractical and a gas-driven generator far too cumbersome. The latter would be much too noisy in golf course work or in close proximity to the microphone. Some thought was given to the vibrator type power pack but was finally discarded in favor of the dynamotor.

The first step in drawing up the constructional details was to choose suitable carrying cases since all design revolved around their dimensions. Much thumbing of the files disclosed the object of our search in a Western Electric case normally designed to house their 22A portable speech input equipment. The outside dimensions are 14 inches high, 16 $\frac{1}{2}$ inches wide and 7 $\frac{3}{4}$ inches deep. This case is not only down to a really portable size but is neat appearing and exceptionally durable.

The Transmitter

Since the inside diameter of the case limited the depth available to about 7 inches, it was decided to follow a "panel-less," sub-base chassis type of construction. Even then, the 807 socket had to be further sunk but all other parts were arranged to fit into and onto a 2-inch sub chassis without a great deal of difficulty. One important advantage of this method of construction is the quick access to all tubes and parts requiring maintenance. This factor also allows taking advantage of one

of the features of this transmitter, namely the easy change of the removable r-f unit.

All parts are mounted on this single sub-base so that the transmitter is installed or removed as a complete unit. Dimensions of the base are 13 inches x 15 $\frac{1}{4}$ inches x 2 inches and formed of eighth-inch aluminum. Thus every bit of available space is used and yet room allowed for removal from the case. Note that the original compartment partition has been removed to accomplish this. The base is also flanged inward, drilled and tapped for fastening with bolts from beneath. A sheet of sixteenth-inch aluminum is bolted to the bottom of the case so that when the trans-

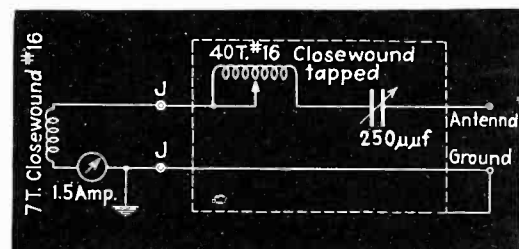

The antenna tuning unit. The 7-turn inductance is L_1 (see diagram p. 20)

mitter is installed, shielding is completed.

Although our purpose was to utilize the intermediate frequencies almost entirely, ultra-high operation also became possible if desired by merely plugging in the ultra-high r-f unit. This unit is complete in itself for each band and includes all inductances and tuning condensers, pretuned. The only other operation necessary is to plug in the proper crystal for each frequency.

The transmitter circuit and tube lineup are quite conventional although there are several unusual



View of the power-supply case which contains also the microphone, cables and antenna tuning unit

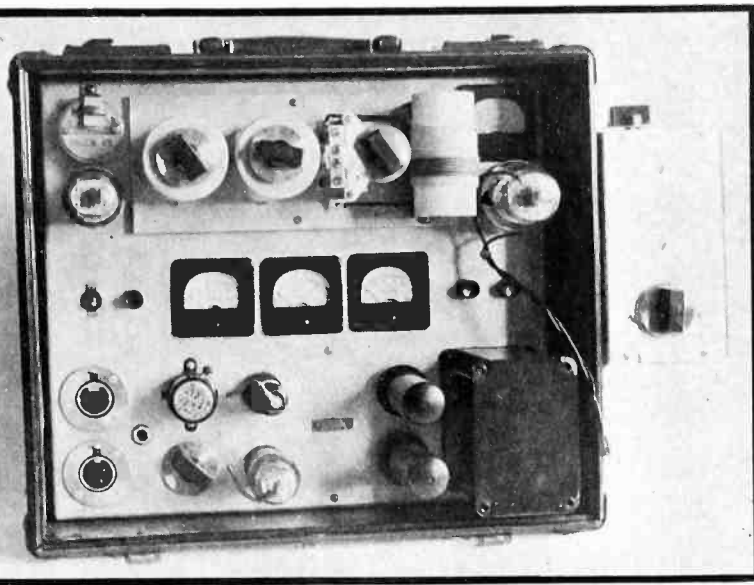

The transmitter proper with top removed and antenna tuning unit in place. The plug-in circuits are at the top

modulation the regulation was found to be excellent.

Input to the dynamotor is 6 volts at a full load drain of approximately 26 amperes. Eleven amperes are required to drive the generator unloaded. Total filament current is 4.1 amperes bringing the total current consumption to approximately 30 amperes.

The filter circuits are straightforward and simple and are contained in an 8 inch x 6 inch x 2 inch metal box. This filter box and dynamotor are mounted on an iron base sheet with a terminal strip in the

middle. The base is $\frac{3}{8}$ -inch thick and its dimensions are 9 inches x 15 inches designed to fit snugly in the large compartment of the carrying case. The terminal board is of $\frac{1}{4}$ -inch bakelite 4 inches x 9 inches in size. On it are located the 4 pin power receptacle, blade switch and battery posts. The whole is raised 5 inches from the base on iron brackets. The small compartment accommodates the antenna loading unit and spare tubes. There is also sufficient space atop the filter box for a hand microphone and power cable. Thus everything is transported in the two cases but the storage battery.

It is advisable to reduce the length of the power cable to a maximum of about 5 feet to prevent too great a voltage drop. A six wire shielded cable was employed with three of the wires connected together for one filament leg. Two wires and the shield formed the other leg which was also grounded. The sixth wire carries the plate voltage.

A small single blade knife switch was incorporated into the terminal board to cut both filament and dynamotor. A stand by plate voltage switch is located on the transmitter chassis.

Antenna Unit

The highest practical length for our vertical antenna was approximately 12 feet for the type transmission intended. Therefore a loading system or partial "dummy" must be substituted for a full length antenna. Since a quarter wave antenna at 2830 kc is approximately 85 feet

long it will be seen that considerable inductance would be necessary.

The necessary elements of a simple, conventional loading device were installed in an aluminum box with overall dimensions of $5\frac{1}{8}$ inches x $3\frac{1}{2}$ inches x 7 inches. The design was such that the tuning knobs would not interfere with its fitting the carrying case small compartment. When in use it is fastened to the outside of the transmitter case by means of brackets and thumb screws. Binding posts set in victron furnish terminals for antenna and ground. Two short leads equipped with banana plugs complete the circuit by connecting to the coupling coil.

The loading constants are merely a tapped inductance and variable condenser. The coil is close wound of No. 16 DCC wire on a 2-inch form. It consists of 45 turns tapped every 5 turns. The condenser is a 250 μf National type TMS. A single pole, 10 position, isolantite insulated tap switch is used to vary the inductance.

The coupling coil, 7 turns, is wound directly over the ground end of the final tank and terminates in banana jacks. By this method either the loading system or a doublet may be used. Normally one end of the coil connects to the antenna meter which in turn goes to ground. The other end series the loading inductance and condenser to the antenna. At ultra high frequencies the antenna connects directly to the coupling coil and thence through the meter to ground.

There are a few points of interest

(Continued on page 59)

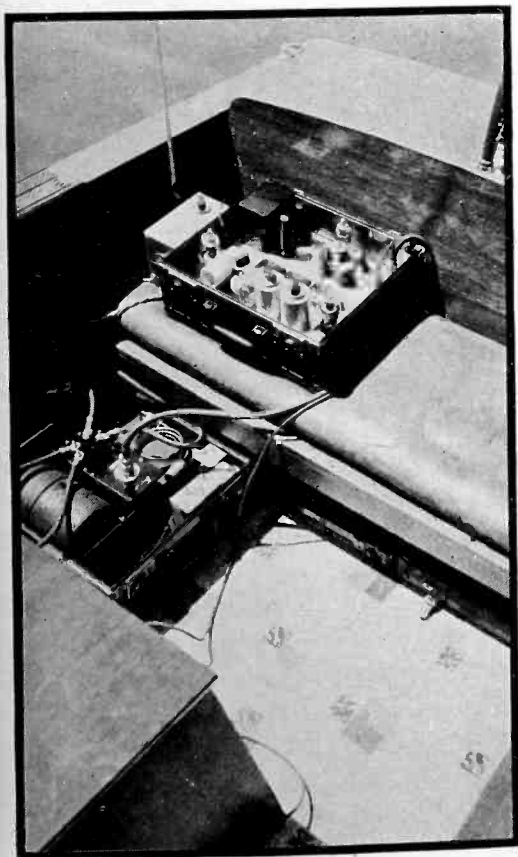

The complete equipment in service on a motor launch

Input Conductance NEUTRALIZATION

By including a small inductance in series with the cathode, the input conductance of tubes operating at high frequencies may be reduced, with resulting greater flexibility of circuit design and improved circuit Q

THE input conductance of a tube used as an r-f amplifier is normally negligibly small at moderate frequencies, for example up to about 25 Mc. Where it is desired to use sharply-tuned circuits at higher frequencies, it is found that tube input conductance rapidly becomes a serious limitation on effective circuit Q. If, on the other hand, the circuits are intentionally broad, as for television service, the deleterious effect of tube input conductance may not become very evident until higher frequencies, of the order of 70 Mc, are reached. Even in this case, however, there are many circuit arrangements where improved performance could be secured if the necessary damping were wholly under the designer's control as to placement and magnitude. This article describes two methods of neutralizing input conductance.

The input conductance of conventional vacuum tubes is determined by three factors: (A) conductance at cut-off attributable to dielectric losses and to the series combination of resistance and capacitance equivalent to the effects of the space charge close to the cathode; (B) feedback from the anode-cathode circuit to the grid-cathode circuit through the grid-cathode capacitance of the tube and the self-inductance of the cathode lead, the latter being common to the input and output circuits; and (C) the transit time of electrons through the tube. For the 6AC7/1852 tubes the second factor is believed to constitute over 80 per cent of the total input conductance, as evidenced by recent calculations and observations. Both the second and third factors are proportional to the g_m of the tube and to the square of the frequency;

By
R. L. FREEMAN
Hazeltine Service Corp.

thus they are difficult to determine separately, and for the same reason may be conveniently simulated *in toto* by an equivalent cathode lead inductance larger than actual. Thus as far as the major part of the input conductance is concerned the equivalent circuit of a vacuum tube is represented by Fig. 1. It can be shown that the conductance G between points g_1 and k in Fig. 1 is given by

$$G = \omega^2 C_{gk} L_k g_m \quad (1)$$

where L_k is the equivalent rather than the actual cathode lead inductance.

Qualitative reasoning applied to the circuit of Fig. 1 is as follows: The voltage drop across L_k caused by the cathode current lags the applied voltage E by 90° . This voltage E_k causes a current to flow back to the grid through C_{gk} which leads E_k by 90° or which is *in phase* with the applied voltage.

Figure 2 shows the neutralizing circuit, which is the same as Fig. 1 except for the added inductance L . The voltage drop E_L across L , caused by the cathode current, is now reversed in polarity with respect to E_k in the sense that C_{gk} and L are in series between g_1 and k . Thus the current flowing back to the grid through C_{gk} is 180° out of phase with the applied voltage E . For a certain value of L the currents through C_{gk} and C_{gg} will be equal as well as opposite in phase; then the conductance between g_1 and k is zero. Proof of this is given in the Appendix wherein it is shown that

the circuit should be proportioned so that

$$\frac{L}{L_k} = \frac{C_{gk}}{C_{gg}} \quad (2)$$

C_{gg} is the inherent capacitance between the grid and all elements of the tube which are at a-c ground potential, stray circuit capacitance to ground, and any added capacitance that might be used.

For the 6AC7/1852 and 6AB 7/1853 tubes the added inductance L takes the practical form of a straight piece of No. 20 wire of about $1\frac{1}{2}$ " in length connected between the cathode terminal of the socket and a ground lug on the chassis. The plate load circuit, the screen grid, and the suppressor grid are returned to the ground lug, while the input circuit is returned to the cathode terminal of the socket. This is illustrated in the sketch of Fig. 3.

When the tube is operated near cut-off there will always be a small conductance between g_1 and k caused by the previously discussed factor (A). This cannot be neutralized when the g_m approaches zero. Hence a neutralization circuit designed strictly in accordance with equations (1) and (2) will reduce the conductance to a small value equal to that of the tube at cut-off, which value will be constant with variations in g_m . Slightly increasing L will provide zero or even negative conductance at large values of g_m and the same small positive value near cut-off.

Since (2) is independent of frequency, neutralization should be independent of frequency. This is strictly true only as long as the frequency does not approach the natural resonant frequencies of the

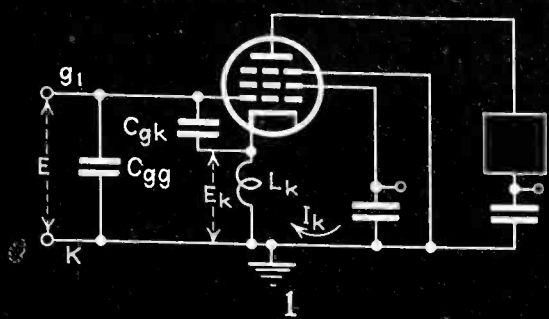

1
Equivalent Input Circuit of
Conventional Amplifier

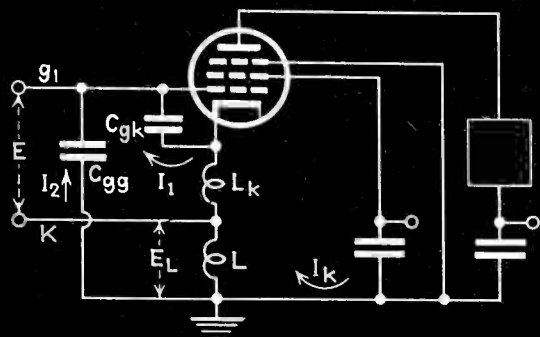

2
Input Conductance Neutralization Circuit

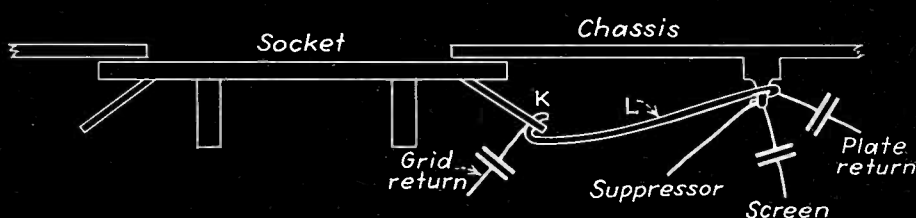

3
Practical Form of Inductance L

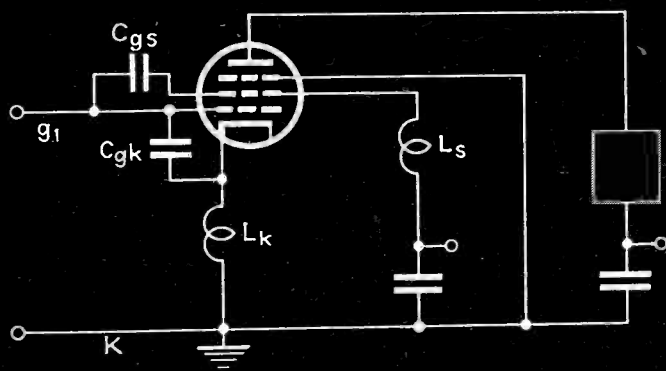

4
Neutralization Circuit for use with
Converter Tubes

capacitances and lead inductances of the tube electrodes. This was checked experimentally for a given circuit using an 6AB7/1853 tube at 13, 20, 40 and 60 Mc. Variations in conductance were of the order of half the conductance of the tube at cut-off. This may be attributed to variations in the stray capacitance between the high side of the various coils and ground and to errors in measurement.

The plate-cathode capacitance of the 6AC7/1852 and 6AB7/1853 is

less than the grid-plate capacitance when the suppressor and screen are grounded. Thus no trouble should be experienced with feedback through the former capacitance.

A very similar means* of neutralizing input conductance, employs an inductance of about 0.1 μ h in the screen grid lead as shown in Fig. 4. Basically this circuit is the same as Fig. 2; there are, however, two differences: the point K (cathode pin) is now at ground potential, and only

* Suggested by H. A. Wheeler.

Figs. 1 to 4—Circuits for analyzing conductance neutralization, and practical construction for application to a receiver chassis

the screen current flows through the inductance L_s .

Since the impedance in the screen lead lowers the shielding effect of the screen grid, the method is especially adaptable to converter tubes, where the plate load impedance is negligible at the frequency of the grid signal voltage.

APPENDIX

Let Y equal the admittance between points g_1 and k in Fig. 2. Let

$$Z_1 = j\omega L_k + \frac{1}{j\omega C_{gk}} \quad (1)$$

$$\text{Then } E = I_1 Z_1 + I_k j\omega L_k \quad (2)$$

$$\text{Since, } I_k = g_m E_g = \frac{g_m I_1}{j\omega C_{gk}} \quad (3)$$

$$I_1 = \frac{E C_{gk}}{Z_1 C_{gk} + g_m L_k} \quad (4)$$

$$\text{Assume, } Z_2 = j\omega L + \frac{1}{j\omega C_{gg}} \quad (5)$$

$$\text{Then } I_2 = \frac{E}{Z_2} \left(1 + \frac{g_m L}{C_{gk} Z_1 + g_m L_k} \right) \quad (6)$$

$$\text{Since } Y = \frac{I_1 + I_2}{E} \quad (7)$$

$$Y = \frac{1}{Z_2} \left(1 + \frac{g_m L + C_{gk} Z_2}{g_m L_k + C_{gk} Z_1} \right) \quad (8)$$

$$\text{Let } \frac{L}{L_k} = \frac{Z_2}{Z_1} \quad (9)$$

$$\text{Then } Y = \frac{1}{Z_2} + \frac{1}{Z_1} \quad (10)$$

For frequencies appreciably less than the resonant frequencies of the L 's and C 's

$$Z_1 = \frac{1}{j\omega C_{gk}}$$

$$Z_2 = \frac{1}{j\omega C_{gg}}$$

Thus (9) and (10) become

$$\frac{L}{L_k} = \frac{C_{gk}}{C_{gg}} \quad (11)$$

$$Y = j\omega (C_{gg} + C_{gk}) \quad (12)$$

Thus under the conditions of equation (11) from which (12) was derived, the admittance Y is independent of the transconductance of the tube and is a pure susceptance.

The Image Dissector

An account of the development, principles of operation, construction and operating characteristics of an outstanding television pick-up camera tube, which has proved its worth as a transducer for motion picture film programs

THE Image Dissector tube is an electronic device for changing light energy into usable electric energy for the purpose of modulating a television carrier in the broadcast of television images. The tube, as its name implies, dissects the optical image to be televised into many thousand picture elements from which the photoelectric currents, in their proper sequence, constitute a video signal.

One of the earliest forms of the Image Dissector tube is shown in Figure 1. *K* is the cathode from which photoelectrons were emitted; *D*—condenser plates for deflecting the electron beam horizontally and vertically; *A*—the anode for accelerating the electrons; *H*—the aperture, and *C*—the collector.

A second form of the Image Dissector employed the use of magnetic fields for focusing and deflecting the electron beam. This tube is shown in Fig. 2. The hatched areas are cross-sectional views of the coil system. The tube is similar to the one described in Fig. 1, except for the box *B*, which entirely surrounds the only part of the collector in the tube that is exposed. This box has on its front face a small hole, the defining aperture.

In the early days, considerable difficulty was encountered in obtaining photo-surfaces of sufficient sensitivity. Television signals from tubes with Na and KH surfaces did not effectively override the random noise from the cathode, and when the change to Cs-Cs₂O-Ag surfaces was made the sensitivity was increased forty to fifty times. An improved form of the Image Dissector used these new photo-surfaces, and the geometrical form of the Dissector, as it is known today, was also adopted, as is shown in Fig. 3. *F* was commonly referred to as the finger and it housed the collector wire *C*. The aperture *H* was punched

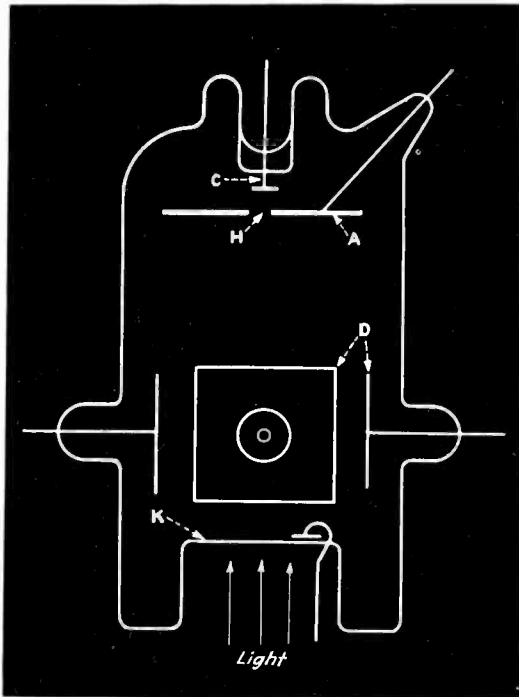

Fig. 1—An early form of the dissector, which used electric deflection

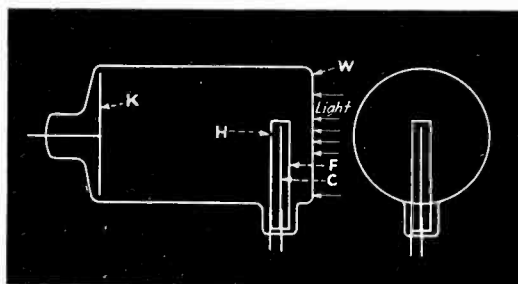

Fig. 3—Improved geometrical arrangement, but no electron multiplier structure

in the side of the finger facing the cathode *K*. *W* is an optically flat window, which allowed the light to be transmitted without distortion onto the solid silver cathode.

A later form of the Dissector, shown in Fig. 4, included an r-f type electron multiplier. The initial photo-currents from the cathode, after passing through the aperture, were made to oscillate between two surfaces having secondary emission ratios greater than one. Every time an electron bombarded a surface it would knock two or more secondary electrons out of the surface, and these would be accelerated toward the opposite surfaces, resulting in

By C. C. LARSON
and
B. C. GARDNER

Farnsworth Television Inc. of Penna.

further gain. After a number of oscillations had occurred, all of the electrons were collected, and the process again repeated. Figures 5 and 6 are pictures of completed tubes containing r-f type multipliers.

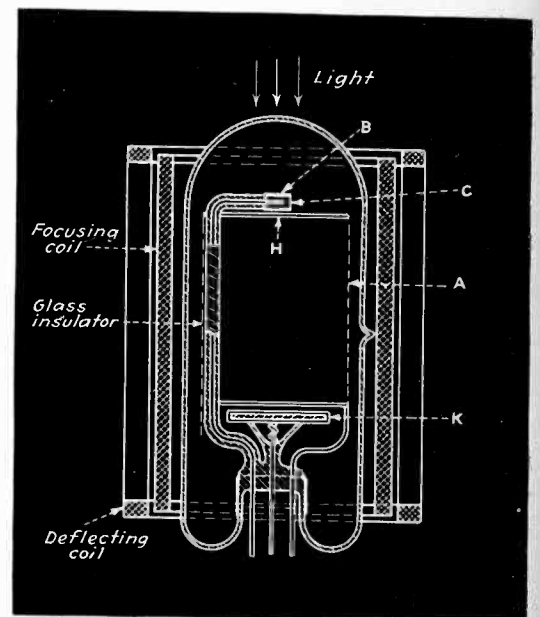

Fig. 2—Tube using magnetic deflection for moving electron image past scanning aperture

While r-f type multipliers functioned well, further development indicated that somewhat greater stability could be obtained with multipliers of the electrostatic type. The new electron multiplier incorporated in the Image Dissector tube was of the electrostatic type and depended upon static voltage conditions between successive stages for electron multiplication. This type of multiplier will be discussed in detail later.

Figure 7 is a picture of a completed Image Dissector tube with an electrostatic type electron multiplier. The tube shown in Figure 7 was successfully used and gave excellent

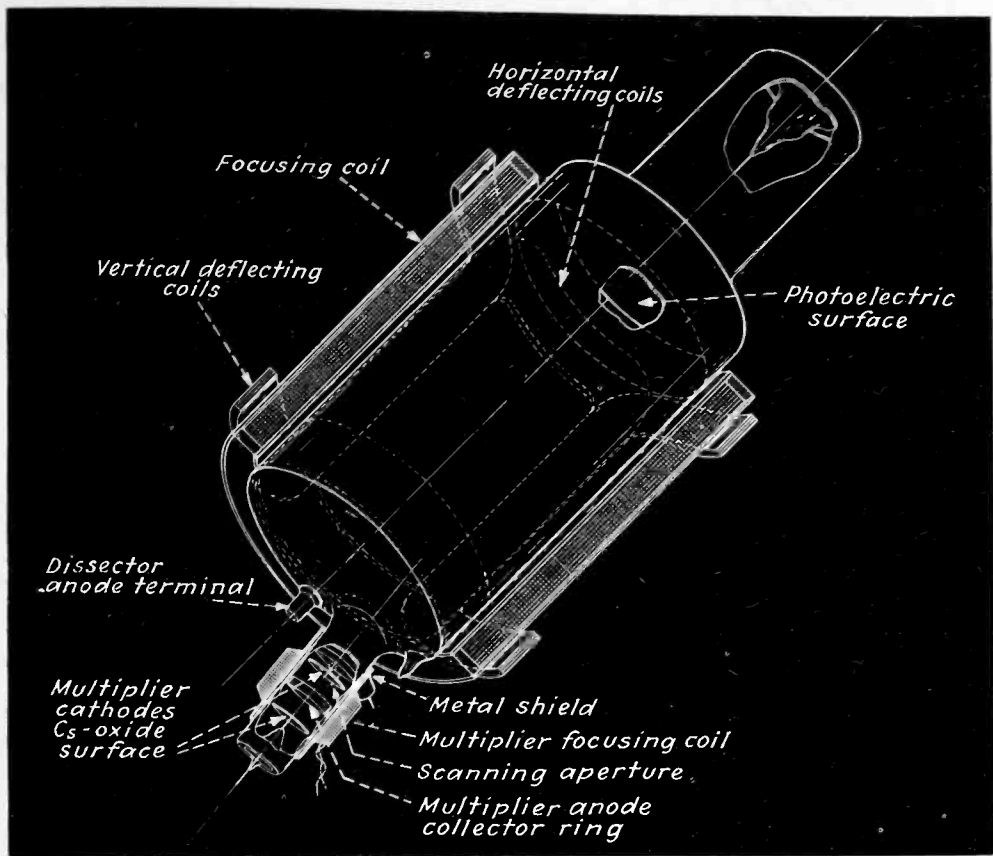

Fig. 4—The image dissector with the r-f type electron multiplier structure which made it a practical pick-up device

television pictures, but active research, which was constantly encouraged, resulted in improvements in mechanical design, electrode geometry, photoelectric and secondary emission surface formation, etc. As a final result, the present-day Dissector, shown in Fig. 8, is capable of giving excellent performance and is especially adapted to telecine (televised motion picture) application.

Theory of Operation

The essential parts of an Image Dissector are the cathode, the anode, the electron multiplier and the scanning aperture. The tube is illustrated in Figure 9. The photoelectrons emitted by the cathode, due to the optical image focused upon it, are focused by means of an axial magnetic field so as to form an electron image in the plane of the aperture. All of the photoelectrons that leave a given point on the cathode surface do not have velocities in a direction normal to the cathode surface. If all the electrons of random velocity distribution from a given point on the cathode surface are made to converge at a corresponding point in a plane parallel to the cathode plane, an electron image is formed. The potential difference between the cathode and the anode accelerates the photoelectrons so that, in conjunction with the axial magnetic field, a sharply fo-

cused electron image is formed in the plane of the aperture. This electron image is deflected both horizontally and vertically by applying transverse magnetic fields. The motion of the electron image past the aperture results in progressively selecting areas of the image, causing a progression of electron bombardments of the first segment of the multiplier corresponding to respective areas of the original optical image. This process is one of "dissecting" the electron image and is the origin of the name "Dissector."

The photoelectrons that enter the aperture in the entrance face of the first segment are primary electrons striking a secondary emission surface. The secondary electrons emitted are focused on a successive segment or stage, and at this stage each electron again becomes a primary and is responsible for more secondaries. In this way a tremendous gain over the original input current through the aperture is obtained.

Construction of Image Dissector

At the present time—and probably for a long time to come — each Dissector that is produced in the Laboratory is treated as an individual unit, i.e., the production of Dissector tubes is unlike the mass production of simple photoelectric cells and radio tubes. The variables that enter into the completion of a Dissector are many and difficult to control. For that reason, a routine or schedule has been developed in Dissector assembly and pumping that is closely followed.

The glass blank used in Dissector assembly is of pyrex with a shoulder at one end for supporting the cathode and a polished flat window at the other end to admit light. The cathode is held tightly in place against the shoulder by means of a tungsten spring support, the termination of this support spring being brought out of the blank as the cathode terminal. The electron multiplier is sealed on the side wall of the Dissector close to the window

Fig. 5—Upper left, early form employing r-f multiplier. Fig. 6—Lower left, later r-f form. Fig. 7—Lower right, electrostatic type multiplier. Fig. 8—Upper right, final modern form, using electrostatic multiplier and window shaped for motion picture images

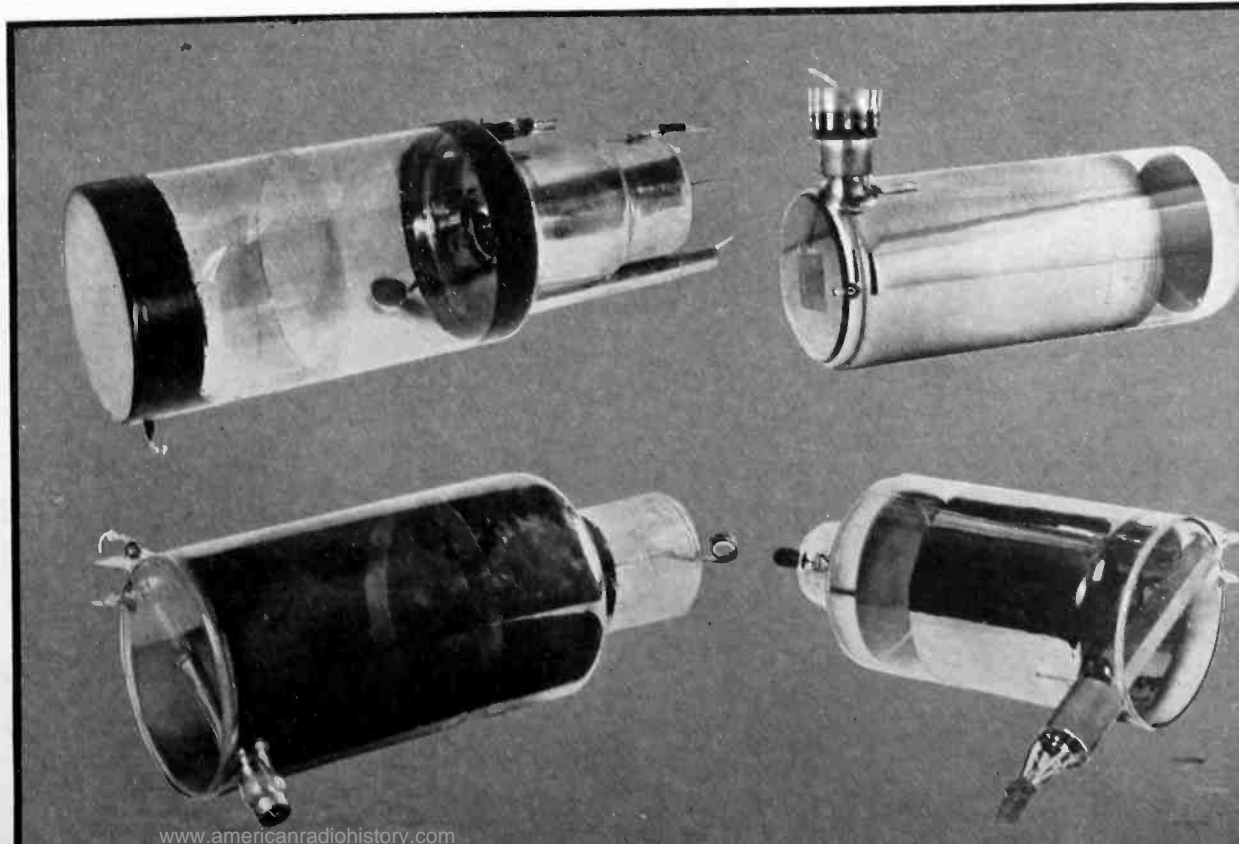

end. It is displaced from the axis of the tube so as to allow a sufficiently wide opening to admit light through the window.

The cathode is a spun pure silver cup with a flat bottom, $4\frac{1}{2}$ inches in diameter and a rim $\frac{3}{4}$ inches wide. The cathode surface is polished to a mirror finish and then etched. Etching is accomplished by heating in air with a hydrogen flame to a temperature of about 500 degrees C. The cathode is held fast and the flame directed at the cathode surface from below with a slow oscillatory motion parallel to the surface.

A very fine and uniform etch is obtained with this method and is very satisfactory for television photoelectric surfaces.

The anode is a cylinder of evaporated nickel closed at one end except for the window through which the light rays of the image to be televised are transmitted. There is a $1\frac{1}{2}$ inch gap between the edge of the cathode rim and the top of the anode cylinder. In the completed tube the axis of the cathode and the anode cylinder coincide.

The electron multiplier consists of eleven stages for multiplication and

of any contaminating substances settling on its surface.

Each Dissector is pumped 18 hours. The tube is baked at 460 degrees C for the first ten hours and is given a 5-hour bake at 80 degrees C after the surfaces are formed. Forming the Dissector photo-surface differs from the usual formation for Cs-Cs₂O-Ag surfaces in that oxygen gas is admitted after the Cs has been distilled on the surface. This offers an additional control over uniformity of photo-emission from different areas of the cathode surface. Oxidation of the Ag surface is accomplished in the usual way in a glow discharge in the presence of oxygen. The oxide thickness is controlled by observing the interference colors the cathode goes through, the glow being interrupted when the proper color is obtained. The multiplier segments are individually oxidized in the same manner, i.e., a glow discharge in oxygen. The oxide is controlled by observing the current in the discharge for a given time interval for each segment.

After the cathode and the multiplier segments have been oxidized, the tube is pumped to remove the oxygen and when a certain minimum pressure is obtained, as observed on an ionization monometer, the tube is ready for the caesium.

It has been found, in order that Dissectors of uniform characteristics may be obtained, that there is an optimum temperature ratio between the cathode and the glass blank. When this ratio is approached, the Cs is flamed into the tube. The tube is brought up to temperature in a hot air oven following a given time-temperature schedule, and at a certain time a short interval is allowed for distilling the Cs into the tube. The cathode again goes through a sequence of colors while the Cs is impinging upon it and these colors offer control over the amount of Cs used. The multiplier stages also react with the Cs forming a good secondary emission surface. Oxygen is admitted which again changes the color of the cathode and completes the formation of the cathode and multiplier surfaces.

Figure 11 is a photograph of a Dissector pumping station. The tube, surrounded by the glass chimney, is being brought up to tem-

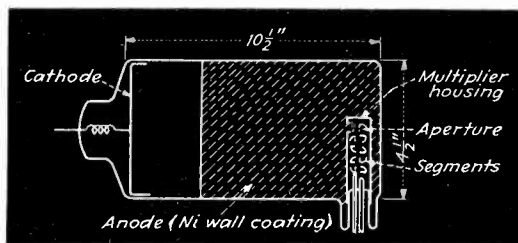
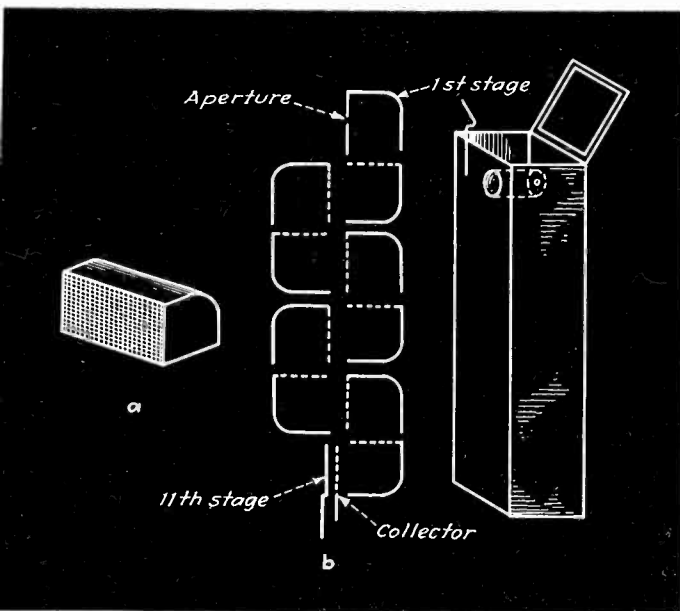
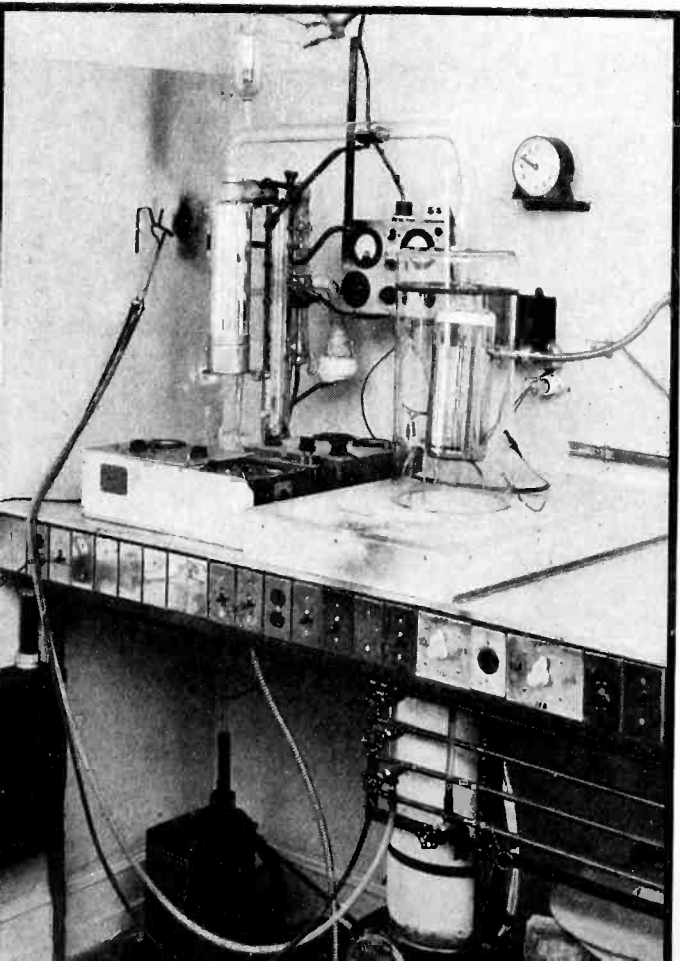

Fig. 9 — Diagrammatic view of modern dissector structure, using static multiplier

Fig. 10—Detail of 11-stage electrostatic electron multiplier used in the present form of dissector

Fig. 11—The pumping position in the Farnsworth Laboratories where dissector tubes are produced



a collector. The first ten stages are segments, constructed of monel metal electroplated with silver. These segments, Fig. 10-a, are quarter circular boxes with closed sides. On the receiving face of each of these segments is fastened a 90 percent open fine wire screen which is for the purpose of maintaining a proper potential distribution in the multiplier. The eleventh stage is a flat monel plate, upon which has also been deposited silver, of the same dimensions as the exit face of the tenth stage. The collector is between the tenth and eleventh stages, as shown in Fig. 10-b. The collector is a fine wire mesh on a framework of the same dimensions as the eleventh stage.

The aperture is a die-punched hole in .002 inch nickel foil which is fastened to the entrance face of the first stage. The eleven-stage multiplier is mounted on a 12-wire stem and is shielded with a metal box $3\frac{1}{2}$ inches long by $\frac{5}{8}$ inches deep and $\frac{1}{8}$ inches wide. The metal parts in the multiplier are all vacuum-fired before the multiplier is assembled. The cathode is the last part to be sealed into the tube. This is to decrease the probability

perature by a blast of hot air from below, preliminary to distilling in the Cs.

The photoelectric sensitivities of Dissector cathodes are of the order of 30 to 45 microamperes per lumen. These sensitivities are determined from measurements using a standard tungsten lamp as a light source at a color temperature of 2710 degrees K. The light flux falling on the cathode can be calculated from the formula:

$$F = \frac{AC}{d^2}$$

where F is the flux in lumens, A the

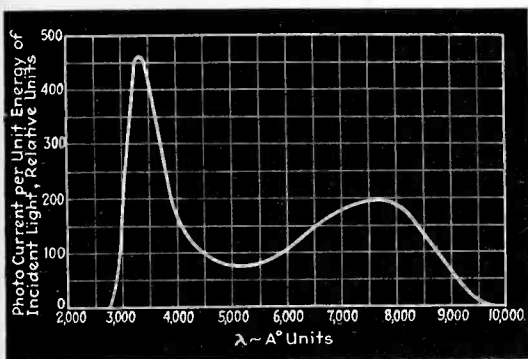

Fig. 12 — Above, spectral sensitivity curve of a typical image dissector surface

Fig. 13—Right, total current yield from dissector with light from a tungsten lamp operating at 2800° K.

multipliers are normally operated at about 100 volts per stage and for an average multiplier S can be taken as 2.6. The calculated output current for the high lights from the multiplier, using this value of S , is 50 microamperes. The overall multiplier gain at this level is 42,000.

Noise due to shot effect from the cathode can be calculated from the shot effect equation:

$$i\Delta_t = \sqrt{\frac{i_0 e}{\Delta t}}$$

where $i\Delta_t$ is the current responsible for noise; i_0 the current for one picture element; e the electronic

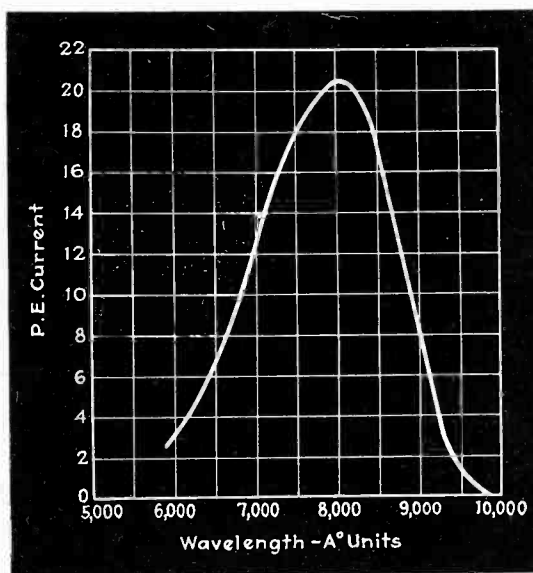

area of the cathode illuminated, C the intensity in candles of the light source, and d the distance between the cathode and the light source.

A Dissector having a sensitivity of 35 microamperes per lumen and illuminated with a high light brilliance of 200 foot candles will produce a calculated primary current through a 5 mil by 5 mil aperture of 1.2×10^{-9} amperes. This is current from the high light areas on the cathode. The multiplier gain can be calculated from the formula

$$i = i_0 S^n$$

where i is the output current from the multiplier, i_0 the initial photocurrent that gets through the aperture, S the secondary emission ratio of the multiplier surface and n the number of stages. This assumes that S is the constant for every stage. S is a function of the voltage between stages up to about 400 volts per stage, which is the maximum voltage for peak secondary emission for cesiated surfaces. Dissector

charge; and Δt the time for transmission of one picture element. Theoretical signal-to-noise ratios of 30 to 1 are obtained in using this equation. For 30 frames per second

$$\Delta t \text{ is } \frac{1}{2.7 \times 10^6 \times 30}$$

In the laboratory, work is now in progress to determine the noise level experimentally from the output lead of the multiplier.

Measurements indicate that in the case of the photocell multiplier noise of sufficient magnitude to be objectionable originates on the cathode. Consequently, it is reasonable to assume that the noise originating in the multiplier of the Dissector is down against the cathode noise in the ratio of the gain of the secondary electrons leaving the target to the photoelectrons that strike the target or the secondary emission ratio of the first stage.

For 441-line resolution and an aspect ratio of 4 to 3, and assuming the size of the optical image

focused on the cathode to be 3 inches wide and $2\frac{1}{4}$ inches high, the scanning aperture used is .005 inches by .005 inches. If the ratio of the optical image to the electron image is 1 to 1, the theoretical resolution will be obtained. This aperture size divides the image into 270,000 picture elements. The aperture, which is die-punched in nickel foil, is kept within a tolerance of .0001 inch.

Special Consideration of the Image Dissector. 1. Spectral Sensitivity

The photo-sensitive cathode of the Image Dissector has the usual color response characteristic of Cs-Cs₂O-Ag surfaces. Figure 12 shows a spectral sensitivity curve for a Dissector. The curve peaks in the infra red at about 7500 A. This curve is for photo-current per unit energy of incident monochromatic light as measured with a thermocouple and a VanCittert Monochromator.¹ The peak in the ultra-violet is due to the absorption of pyrex glass.

Figure 13 shows the total photoelectric yield from a Dissector using a tungsten lamp at about 2800° K. The combination of the spectral energy distribution for a tungsten lamp and the color sensitivity of the Dissector causes the peak to occur at 8000 A. In a television projector using a tungsten lamp as a light source, the point of "best" focus on the Dissector cathode is in the infra red about 8000 A.

2. Freedom from Shading

Since the initial signal from the cathode of the Dissector consists purely of photoelectrons and does not depend upon picture element capacitance effects and secondaries, the output signal from a Dissector is entirely free from shading. This eliminates the necessity of using corrective circuits for cathode shading and greatly simplifies circuit engineering.

3. Blanking

The Dissector is inherently a direct-coupled device and, consequently, can be made to deliver all of the background information if a constant reference level can be inserted in the output signal. This

(Continued on page 50)

Effect of Microphone Polarity on Percentage Modulation

The assymetry of male speech waves (by which most commercial announcements are carried to the audience) makes possible 150 per cent modulation without distortion or sideband chatter, if the proper microphone polarity is used

By J. L. HATHAWAY,

Engineering Department, National Broadcasting Company

MANY broadcast operators have noticed that their modulation monitors sometimes indicate appreciably greater downward modulation than upward or vice-versa. Those who have checked transmitter output closely with a cathode ray tube have no doubt noticed the same thing; often peak amplitude is much greater in one direction than in the reverse.

Some years ago, during the development of an automatic audio gain control in the National Broadcasting Company laboratory, an extreme dissimilarity of peak amplitudes was noticed on a speech wave. Yet when sine wave tone was applied to the unit on test, the waves seemed exactly similar on positive and negative peaks. This led to a search back along the circuit to find which amplifier was overloading, or if the microphone might be the offender. Data showed that the amplifiers involved were not even close to overload and that the microphone gave symmetrical response to sine wave tone. The answer was found to be that the speech sound waves were unsymmetrical and that the loss of low frequency response in the microphone and amplifiers accentuated the dissymmetry. Speaking very close to a velocity microphone so accentuated the low frequency response that deficiencies farther along in the system were compensated for. In this particular case little, if any, dissymmetry of peak amplitude was noticed, although at greater speaking distances a two to one ratio of peak amplitude existed.

Succeeding tests showed that most male voices consistently have peaks

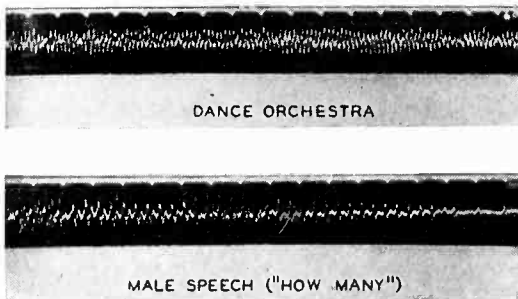

Fig. 1—Typical audio frequency oscillograms. The male speech displays much higher peaks above than below the axis

in one phase about twice as great as in the reverse. This is with typical high fidelity microphones and amplifiers. The photograph, Fig. 1, was made of a typical voice wave on a cathode ray oscilloscope. Female voices generally give a slightly smaller ratio of positive to negative peak amplitude, although some of them are at least two to one. Certain orchestral instruments give a two or one ratio, however, in most orchestral pickup work nearly all of the sound at the microphone has been reflected one or more times, causing the dissimilarity to be averaged out, as shown photographed on Fig. 1.

In the case of the human voice, singing or speaking, maximum peaks occur on the same side of the zero axis. That is, all persons have maximum sound wave peaks in the same direction, although the ratio of positive and negative amplitude varies with individuals as well as the manner of speaking and the distance from the microphone. After transmission over 1000 miles of good telephone lines some dissymmetry still remains, although it appears to become slightly ironed out, due mainly to small non-linearities in the

telephone line repeaters. The dissymmetry appears to be a function of breath or air passing outward through the vocal organs. The only means of reversing the phase of maximum sound wave peaks is to reverse the direction of the breath. Thus, if air is sucked in through the vocal organs while talking, a reversal from normal occurs. This, however, is rather difficult to do and can be considered as never occurring during ordinary conversation or broadcasting. Thus we have a condition wherein the electrical peak amplitude from a good microphone during speech or singing is appreciably greater in one phase than the reverse. Obviously, the average energy must be exactly equal on each side of the axis, since the microphone transformer, as well as the following circuit, is not capable of passing direct current. It is interesting also to note that as we approach d-c amplification, making the microphone and amplifier flat down to about 15 cps, the dissymmetry diminishes.

In amplifier and transducer systems amplitude distortion is created primarily by the highest peaks of the wave. Thus, when a system has an equal leeway of swing in either direction, the side of the speech wave causing distortion is that of greatest peak amplitude. It is entirely possible for peaks in one direction, on such a system, to distort severely, while the other side does not touch distortion. An interesting condition arises when the system overloads at a lower level in one direction than the reverse. In this case the overload point is a function of the phase and it is en-

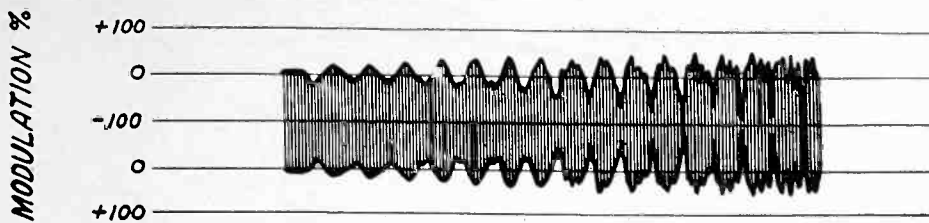

Fig. 2—Modulated carrier with incorrectly phased envelope. The peaks extend toward the axis of the wave

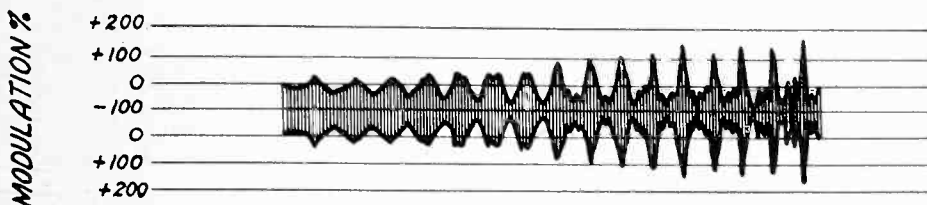

Fig. 3—Same as Fig. 2 but with phase of envelope reversed. Over one hundred per cent modulation is now possible

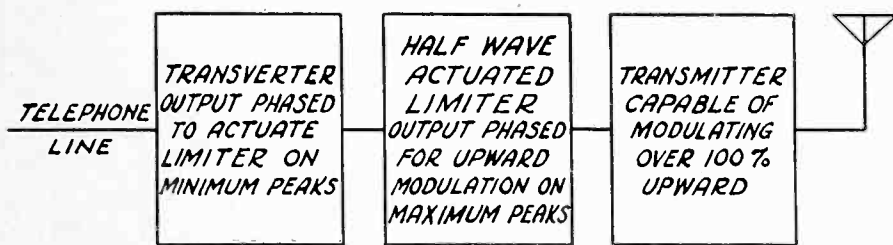

Fig. 4—System for reversing phase automatically as required to maintain maximum upward modulation

tirely possible with such a system to derive *four times* as much undistorted power with one microphone polarity as with the reverse. Obviously, if maximum peaks are applied to the system in the direction of minimum leeway, overloading will be noticed at a lower level than if the phasing were reversed.

Most radio transmitters are good examples of systems wherein the overload point is different on the two sides of the axis. All transmitters are limited to 100 per cent downward modulation, since less than zero carrier cannot be obtained. However, many modern transmitters are capable of swinging upward appreciably above the 100 per cent mark. It is understood that certain recently developed 5 kw broadcast transmitters, for example, will modulate upward to at least 150 per cent. If voice modulation is applied to such a transmitter with maximum peaks phased for downward modulation, the upward peaks cannot exceed 50 to 60 per cent without overmodulation. However, with reversed phase, the upward modulation may hit 150 per cent or more if the transmitter "will take it" before dis-

tortion or voltage break-down occurs. Furthermore, assuming no transmitter nonlinearity, this does not increase adjacent channel interference above that to be expected by the corresponding power increase.

Amateur transmitters and in fact many others can easily be definitely fixed in polarity of the speech waves. This often permits an appreciable modulation increase without distortion, or conversely, a reduction of distortion at the same power. The National Broadcasting Company has recently placed in service a new type pack transmitter employing automatic audio gain control and audio circuits phased to give more than 100 per cent modulation upward. Tests show that if the microphone output is reversed, distortion increases appreciably. Small broadcasting stations can sometimes fix the polarity of all of their microphones for best results. However, in the case of larger stations and networks, this is impractical.

Phase may be reversed whenever amplifiers or telephone lines are changed or different microphones used. In the case of velocity microphones, the phasing is opposite on

opposite sides of the microphone. This is the type microphone employed at the National Broadcasting Company for nearly all dramatic work, the actors using both sides and therefore causing a continual change of the polarity of maximum peaks. As a means of overcoming this, apparatus has been developed for the correction of reversals whereby the phase is changed every time it becomes wrong for maximum upward modulation. The device performing this is reasonably simple and the reversal is accomplished without the introduction of audible click. This implies that the reversals can occur only during program pauses or moments of relative silence, such as during the pause after a word or syllable. This requires that when a phase reversal occurs at the microphone, there is a delay of one word before the "transverter" corrects for it. A unit of this type has been tested on certain National Broadcasting Company transmitters with a resultant increase of upward modulation.

As to the practical value of the automatic reversing system or "Transverter," it is necessary to consider certain factors in addition to the possibility of increased modulation. Practically all of the better present day broadcast transmitters are equipped with modulation limiter devices. These are almost without exception full wave actuated. If a half wave actuated limiter were employed, the transmitter output would jump up and down by as much as 6 db depending upon the phase of the speech wave. However, if the phase were controlled in the circuit ahead of the "limiter," the half wave actuated "limiter" would be more ideal than the full wave type, provided the downward modulation peaks were used for control. That is, the circuit must be lined up so that the upward modulation peaks are of the greater amplitude, but the downward peaks actuate the limiter. In the case of the RCA 96A limiter, for example, the circuit is easily lined up in this manner by disconnecting the diode plate which is rectifying maximum peaks, when these are at the same time giving upward modulation.

Listening tests show that for a given maximum peak in either direc-

(Continued on page 51)

A Network-Selecting Chart

By PAUL J. SELGIN

No. 1

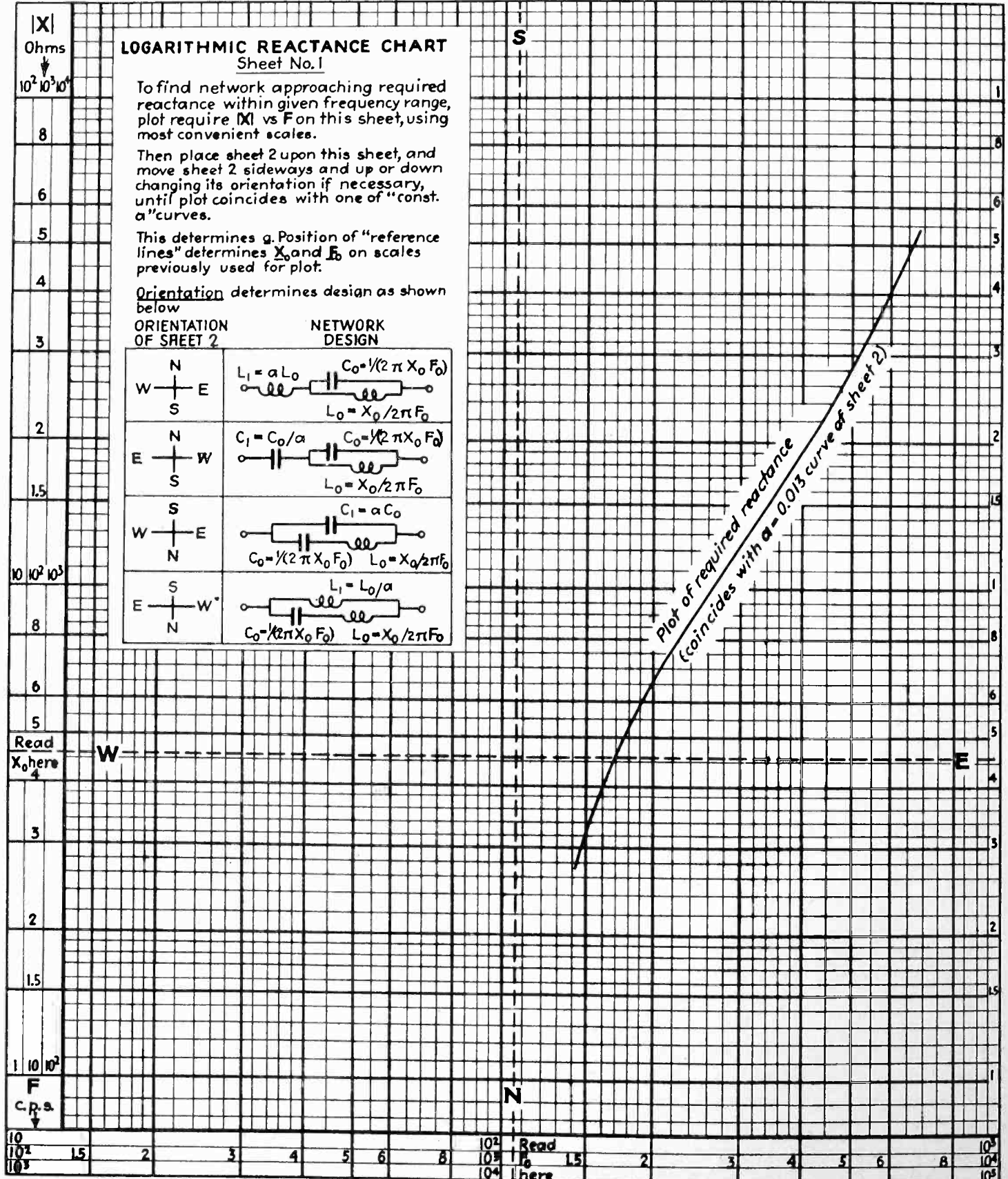

A Network-Selecting Chart

A graphical method of selecting two-terminal combinations of inductance and capacitance which will satisfy given reactance-frequency relationships, useful in designing networks for equalizing and balancing communications circuits

THE evolution of high frequency telephony and of television has brought with it many problems in which the design of passive electrical networks answering given transmission and impedance requirements plays a major part. The solution of such problems presents many mathematical difficulties, as these networks have to be made to measure for each specific case, and no straightforward method of design is available. As an example, the need of equalizing sound or carrier circuits often arises. This may be due to the presence of equipment such as channel or line filters, or to the comparative inefficiency of lines and feeders at higher frequencies. Balancing line impedances to avoid crosstalk is a somewhat similar problem. But whatever the problem, the key to its solution is always the same: A basic two-terminal reactive network possessing a specific variation of reactance with frequency (or, in some cases, several such networks), must be found and made part of the final design.

This required variation is best expressed by a reactance vs frequency plot. One or more such plots may be obtained graphically from the original attenuation or impedance specifications. Plots obtained in this way may or may not correspond to physically-realizable 2-terminal reactive networks. In many practical cases, networks comprising 3 elements (coils and condensers), are sufficiently complex to simulate the required reactance within the useful band to a satisfactory degree of approximation, if their design and the element values are suitably chosen.

The "logarithmic reactance chart" printed herewith achieves this choice in a simple way. The chart contains ordinary reactance versus frequency curves drawn to logarithmic scales, but the curves and the scales are on separate sheets. The chart, which resembles a 2-dimensional slide-rule

By PAUL J. SELGIN

Transducer Corporation

in operation, can be used to obtain the reactance of a given network, or the network having a prescribed reactance variation. For the latter purpose, a reactance plot is drawn on the scale sheet (Sheet No. 1), then the sheets are moved in relation to each other until the plot drawn coincides, as nearly as possible, with one of the existing curves on Sheet No. 2. Two constants, X_0 and F_0 , are then determined by the scale readings at the points where the two "reference lines" on Sheet No. 2 cross the scales on Sheet No. 1. A further constant, a , is associated with the curve that has been "covered." Finally, the relative "orientation" of the two sheets (4 orientations are possible) is noted. The orientation defines the form which the network must have, and the three constants lead directly to the element values, as can be seen on the tabulation accompanying the scale sheet.

Three logarithmic scales are provided for both frequency (cps) and reactance (ohms). They can be used according to the orders of magnitudes involved.

A typical plot of a desired reactance-vs-frequency variation is plotted on Sheet No. 1 for illustrative purposes. When Sheet No. 2 is superimposed on Sheet No. 1, it is found that the best fit occurs between the curves marked $a = 0.01$ and $a = 0.02$ with interpolation at approximately $a = 0.013$. When so positioned, the reference lines on Sheet No. 2 take the positions shown by the dotted lines on Sheet No. 1. These dotted lines are illustrative only, and apply only to the particular example cited. The intersection of the dotted lines with the scales on Sheet No. 1 gives the values of X_0 and F_0 . Thus, if the original plotted curve on Sheet No.

1 applies with the scale of X in 10^2 , and scale of F in 10^3 units then the values are $X_0 = 4.7 \times 10^2$, and $F_0 = 1.1 \times 10^3$. Next the orientation of Sheet No. 2 must be examined. S is found at the top, N at the bottom, W at the left and E at the right. This orientation corresponds with the third shown in the tabulation on Sheet No. 1, hence the reactance network consists of a capacitor shunted by a series-tuned circuit. The values of C_1 , L_0 and C_0 are found by substituting the values of a , X_0 and F_0 , as indicated in the tabulation.

It will be noted that the method is restricted to reactances of three elements or less, with two effective terminals, but beyond this no restrictions apply, so long as the given curve can be fitted to one of the curves shown on Sheet No. 2.

Space does not permit a complete derivation of the theory on which the curves are based. However, briefly, the curves on Sheet No. 2 are plots of

$\log |X|$ vs $\log F$ in

$$X = aF + \frac{F}{1 - F^2}$$

for different values of a , in logarithmic coordinates. The use of log scales permits the shifting of the coordinates relative to the curves without changing the relationships, simply changing the magnitudes of the scales. (Note, however, that no "twisting" of the coordinates is permitted.) Also, the reversal of position indicated by two of the alternative orientations simply produces susceptances for reactances, and results in an interchange of the capacitive and inductive elements, i.e. the reactance of the inverse network is meant. The other two alternative orientations result simply in the replacement of series inductance by series capacitance. These considerations lie behind the table of network configurations given on Sheet No. 1.

A Network-Selecting Chart

By PAUL J. SELGIN

No. 2

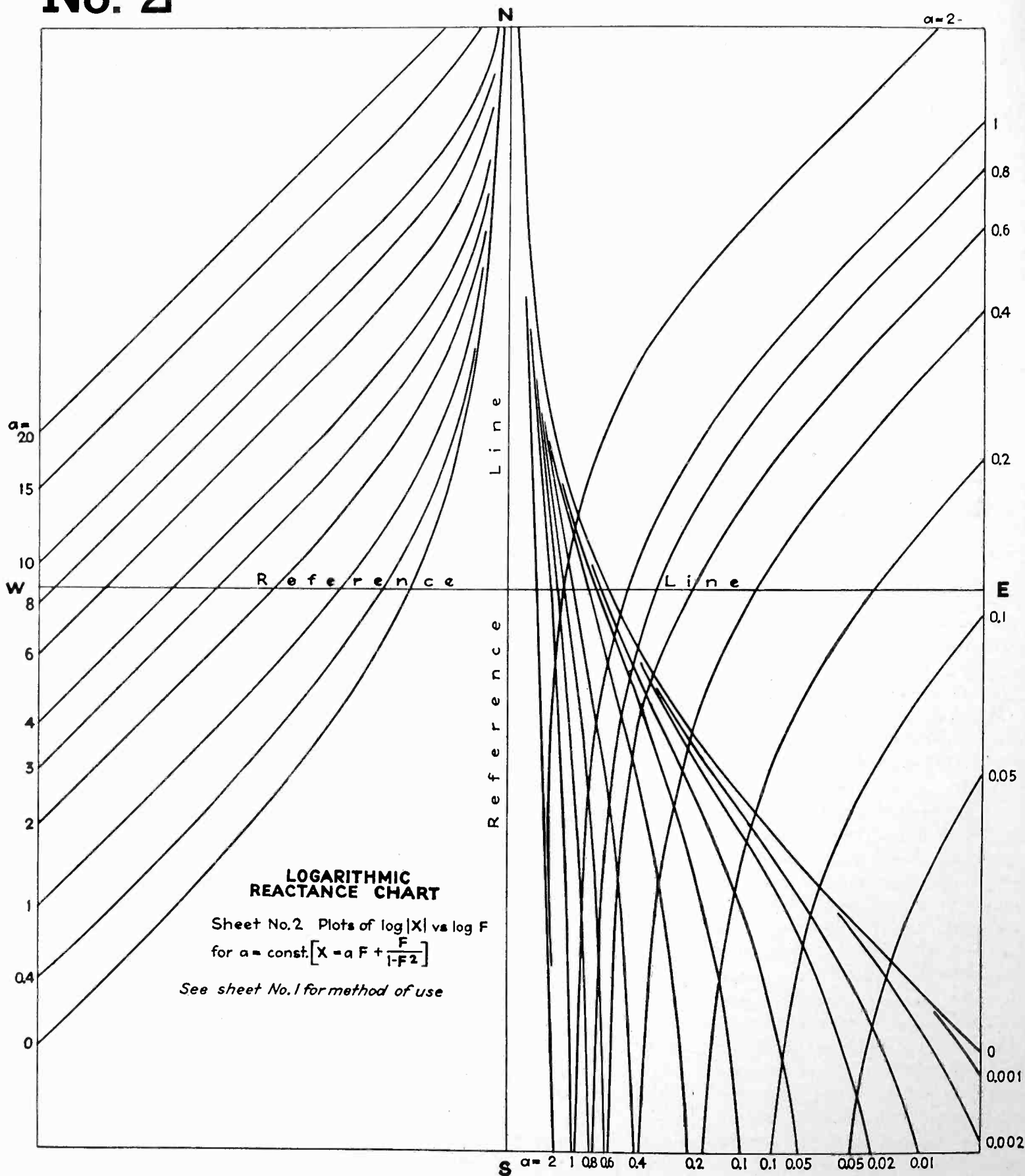

Fibrous Glass Insulation in Radio Apparatus

By REUBEN LEE

Westinghouse Electric & Manufacturing Co.

GLASS insulation has found widespread application in electrical machinery during the past year and is now entering the radio field. Should its use become as popular in radio as it has in power work, there will necessarily be revisions of standards and a need for understanding the nature of this new material.

Glass insulation is made from glass fibers of incredibly small cross section (on the order of 2/10 mil diameter) and in either short (staple) lengths or continuous strands. Yarn formed from the fibers is quite flexible. It may be woven into tape, cloth and sleeving or it may be used to cover wire in place of cotton or silk covering. Coils wound with such insulation withstand higher temperatures, are less affected by corona and resist moisture absorption more effectively than coils wound with organic insulation. For a given current to be carried, the wire may be smaller in cross section if glass insulation is used. It is understandable, therefore, that one of the principal motor applications is in railway service where weight is a paramount consideration and where heavy overloads with consequent high temperatures are often encountered. Recent papers¹ in the power journals describe the advantages of glass insulation. The rapid growth of the use of this material is indicated by the fact that there are today 25 motor manufacturers in the United States who can supply glass-insulated motors.

We may reasonably expect to find radio applications of glass insulation in related fields. Transportation apparatus in general is undergoing continual reduction in weight and size. The advantage of glass in this respect is that it can be run at higher temperatures without increasing size.

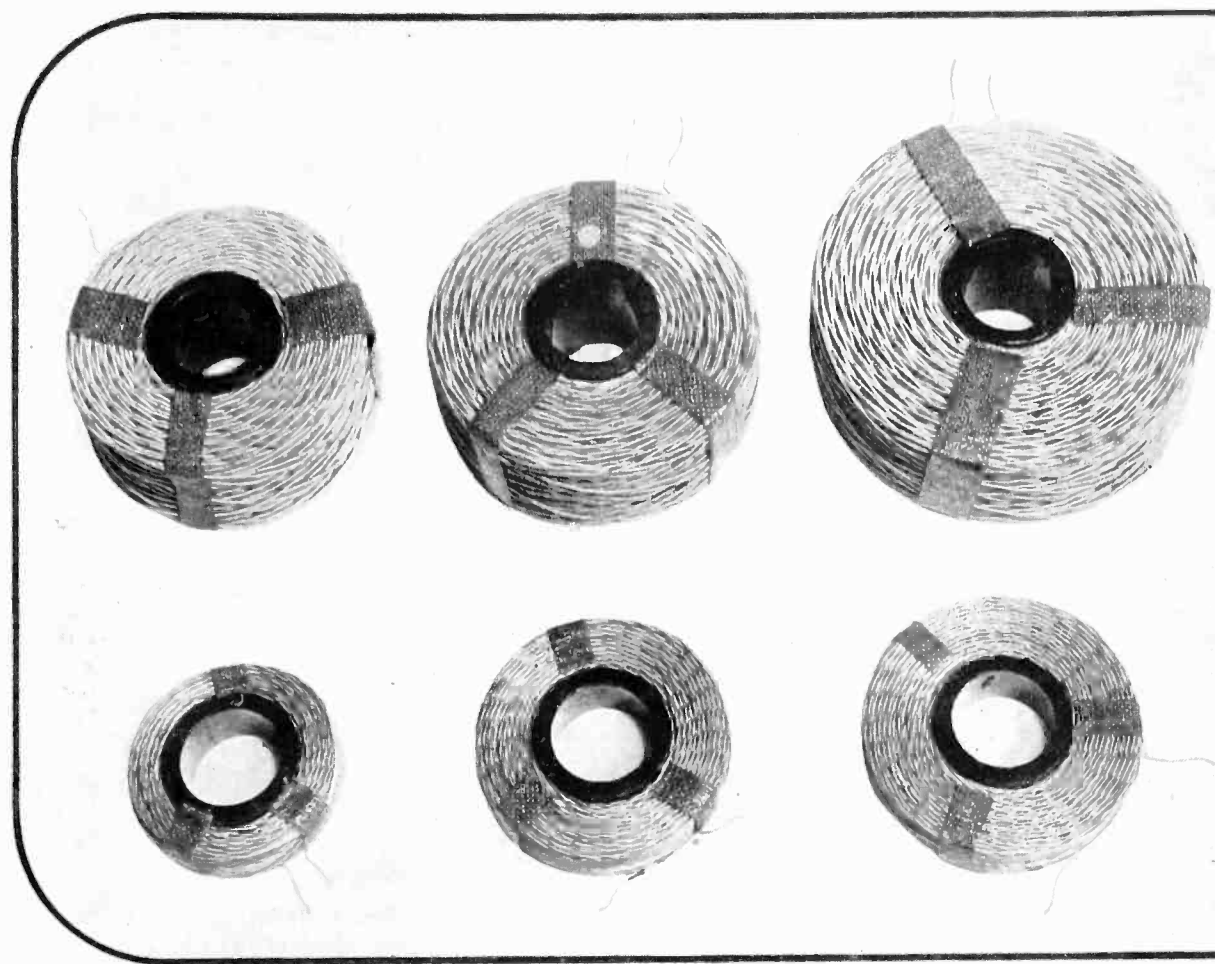

Fig. 1—A comparison of coils insulated with cotton (top row) and with glass (bottom row). The design conditions for both sets were the same except for temperature rise and they perform equally well

It is the purpose of this article to indicate how glass insulation can be applied advantageously in radio apparatus. Although glass is highly resistant to moisture absorption and to corona, these advantages are contingent upon the use of proper impregnants just as with cotton insulation. Where impregnants are not necessary, the advantages of glass insulation are usually already present, for example, in h-f coils having ceramic forms and uninsulated wire. The discussion will hence be confined to impregnated coils which hitherto have been cotton or silk insulated. Since the problem now centers chiefly on the insulation temperature, it is well first to review this subject insofar as it applies to radio.

In comparing the temperature limitations of glass and cotton insulation, it is worthy of notice that glass falls under the A.I.E.E. designation of Class B insulation, and cotton under Class A insulation.

This classification assumes impregnation of both materials with organic compound. Maximum allowable temperature rise of each class of insulation is:

- Class A—55°C rise
- Class B—75°C rise

These figures are based on a 40 degree C ambient temperature. The Class A insulation limit is a definite figure based on empirical data gathered over many years. On the other hand, the Class B limit is an arbitrary conservative standard, adopted with the recognition that manufacturers can successfully make coils capable of withstanding much higher temperatures. The indefinite nature of this limit arises from the wide differences in properties of impregnating compounds and the practical impossibility of limiting the amount of Class A materials, allowed for structural purposes, in the coil.

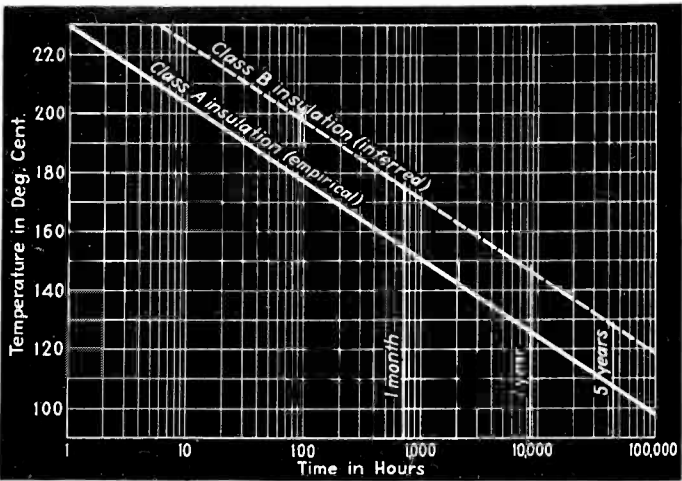

Fig. 2—Life expectancy curves of cotton (Class A) and glass (Class B) insulation

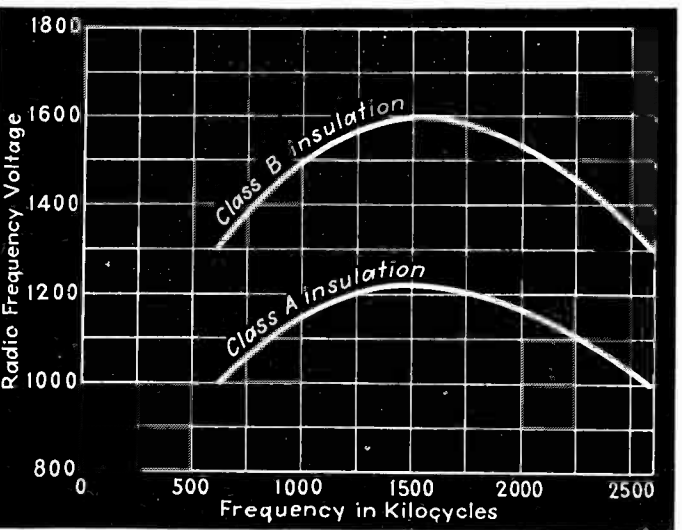

Fig. 3—The use of glass insulation increases the permissible radio frequency voltage across the coil

Experience upon which the Class A limit was based established that provided the limit is not exceeded, several years' life can be expected of the insulation. For short intervals of time, the limit may be exceeded materially without damage. The solid curve of Fig. 2 shows the approximate life expectancy of Class A insulation, versus maximum operating temperature (ambient plus rise plus 10 degrees C allowance for hot-spot). The dotted curve of Fig. 2 is the life of Class B insulation which would be expected if the A.I.E.E. standard limit were applicable in any particular coil. The materials used and the manufacturer's expertness in applying these materials determine largely whether this is the actual life curve or whether considerable increase in operating temperature is permissible.

The accumulation of data necessary for a curve such as Fig. 2 requires several years' time or longer than can be taken before setting operating temperature limits for a new material like glass. A valuable

basis can be had however, by comparing the life of glass insulation with organic insulation when the latter is operated at the higher temperatures of Fig. 1. Laboratory tests can thereby be conducted in a short time.

A set of coils all alike except for class of insulation was tested by connecting them across a suitable 60 cycle voltage supply. The voltage was high enough to cause a high operating temperature, which was of course the same for each coil. The initial drop in current was the result of increasing coil resistance and when a final rise in current occurred, the cause was coil insulation failure. All the Class A insulated coils failed 30 minutes after voltage was applied. All the glass insulated coils were still operating after 29 hours, with no signs of incipient failure. By the end of that time, nearly all of the impregnating compound was burned out of the coils, leaving them mechanically weak.

Two points are worth mentioning in connection with these tests. First, they simulate actual working comparisons. That is, the general shape of the curves would be the same if the abscissas were months instead of minutes, corresponding to a lower operating temperature. Second, except for mechanical strength, the upper temperature limit for glass insulation is its melting point. Wherever coils depend upon impregnation for mechanical rigidity, the upper limit is set by the impregnating compound. The higher the safe operating temperature of the compound, the hotter the coil can be without damage.

The results of these tests were applied to the re-design of a set of standard universal wound plate chokes. Since r-f power must be conserved, it was specified at the outset that the watts dissipated in the new coils were to be no higher than in the old coils. The frequency range was to remain unaltered. The r-f volts per turn must be limited to a value well below the corona limit to safeguard the life of the impregnant and the d-c plate current was to remain the same. Figure 1 illustrates the size reduction that was accomplished while fulfilling these requirements. The glass insulated coils in the lower row perform at least as well as the respective coils in the upper row and they operate at a

higher internal temperature. The average weight and size of the glass-insulated coils in percentage of those for cotton insulated coils are as follows:

Weight	25%
Diameter	67%
Length	43%

An idea of the increase in radio frequency voltage permissible across a given coil wound (a) with cotton insulation on the wire, or (b) with carefully applied glass insulation (all dimensions remaining the same) can be had from Fig. 3. In this case the r-f watts consumed in coil loss increase as the square of the voltage and the comparison is useful only where such an increase in coil loss can be tolerated.

Summarizing these results, the use of glass insulation instead of cotton or silk in r-f coils has one or more of the following advantages:

- Raises the operating voltage over a given frequency range.
- Extends the frequency range for a given value of r-f voltage.
- Raises the permissible d-c plate current which flows through the coil.
- Makes available for higher voltage coils of small dimensions.

It should not be concluded from the foregoing that glass insulation is applicable only to the choke in radio apparatus. Similar gains can be obtained in power components as well as coils, especially in transportation apparatus where weight is at a premium. This was demonstrated recently by the substitution of glass for cotton in aircraft radio power transformers with weight reductions averaging 30 per cent. Not only were these reductions accomplished without sacrificing efficiency; the life expectancy was also increased over 100 per cent.

While it would be difficult to predict accurately the extent of the application of the material to radio, it does seem probable that glass insulation will take the course outlined above. The increased resistance to moisture and other deteriorating elements is already proving useful. But whatever future developments may bring, it is certain that glass ultimately will supersede cotton and silk in some specific instances, while in others, it will not.

¹ Ferris and Moses: "Fibrous Glass for Electrical Insulation." *Electrical Engineering*, December 1938.

Ben Remyan

... IN THE FAMILY OF CINCH PLUGS



... THE FEATURES ARE EXCLUSIVE*!

APPROXIMATELY
TWICE ACTUAL SIZE

... and everywhere these handy, efficient compact plugs are well received ... in mounting demand. With an exclusive space saving convenience; $\frac{5}{8}$ " diameter type with one to five prongs, $\frac{3}{8}$ " diameter type with two to nine prongs, they are easy to attach! And with considerable saving in labor assembly!

Consider these advantages: (a) vibration-proof electrical contact; (b) positive grounding of shield on cable assembly; (c) complete metal shielding to point of plug insertion; (d) maximum clearance between contacts—a designed-in feature. Two combinations permit distinct methods of grounding the shell; one for surface mounting, (not illustrated), the other for subpanel or offset bracket mounting, (as illustrated). Socket for both groups assembled with original "CINCH" floating contacts. Soldering tail on contacts where necessary is provided with pocket or dam to receive surplus solder.

Shells supplied with curled neck for ease in gripping or with straight edge for soldering braided metal cables. Male plug is firmly and simply fastened into the shell by bending over four small fingers. The No. 7051 pictured here now supplied with a one-piece insulator; a definite improvement and saving in cost.

★ Features: The extra long center pin acts as a "finder". And the snap-in plug-button type grounds and grips. With sub-panel mounting type, plug-button permanently fastened to the shell will completely shield and hold the plug when inserted

CINCH MANUFACTURING CORPORATION

2335 WEST VAN BUREN STREET, CHICAGO, ILLINOIS
Subsidiary: United-Carr Fastener Corp., Cambridge, Mass.

"Cinch" and Oak Radio Sockets are licensed under H. H. Eby socket patents

ACTUAL SIZE

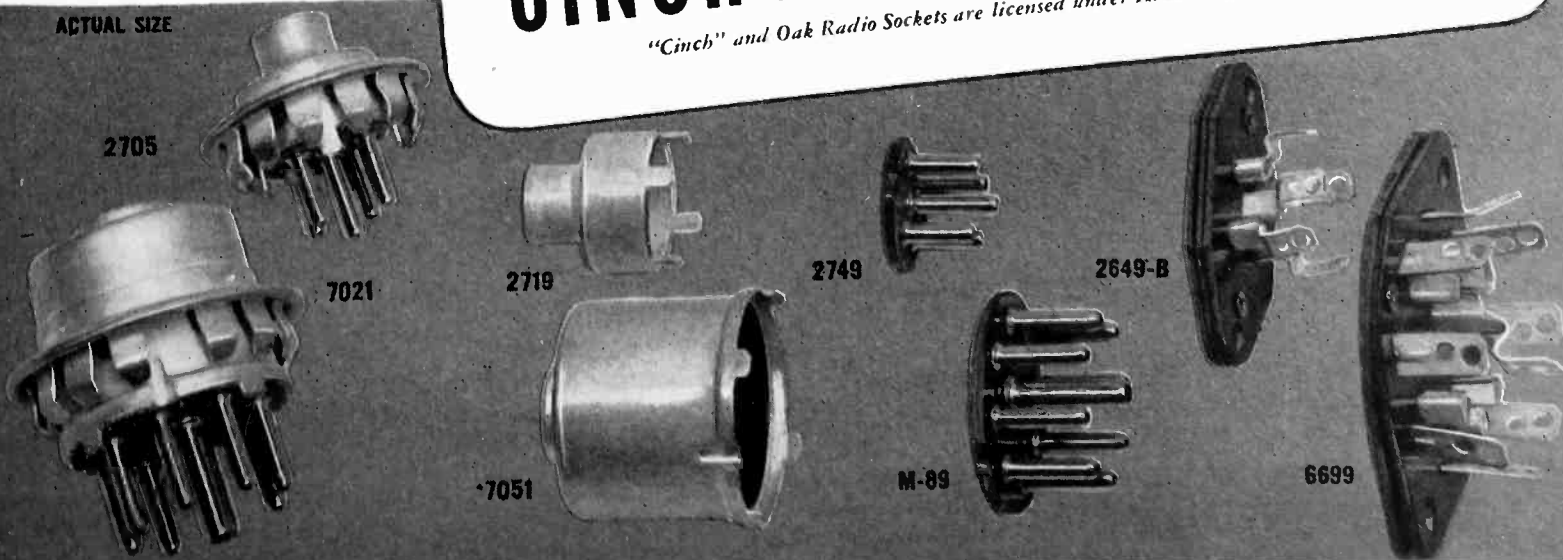

To Record OPE

WESTINGHOUSE GRAPHIC INSTRUMENTS

Here are the instruments that both read and write. For measuring and recording values continuously in any electrical operation, or in any mechanical operation that can be recorded electrically.

These instruments are available in a variety of types, depending on chart length and accuracy required. Portable, socket or switchboard, light in weight and easy to operate. Low energy consumption and simple construction.

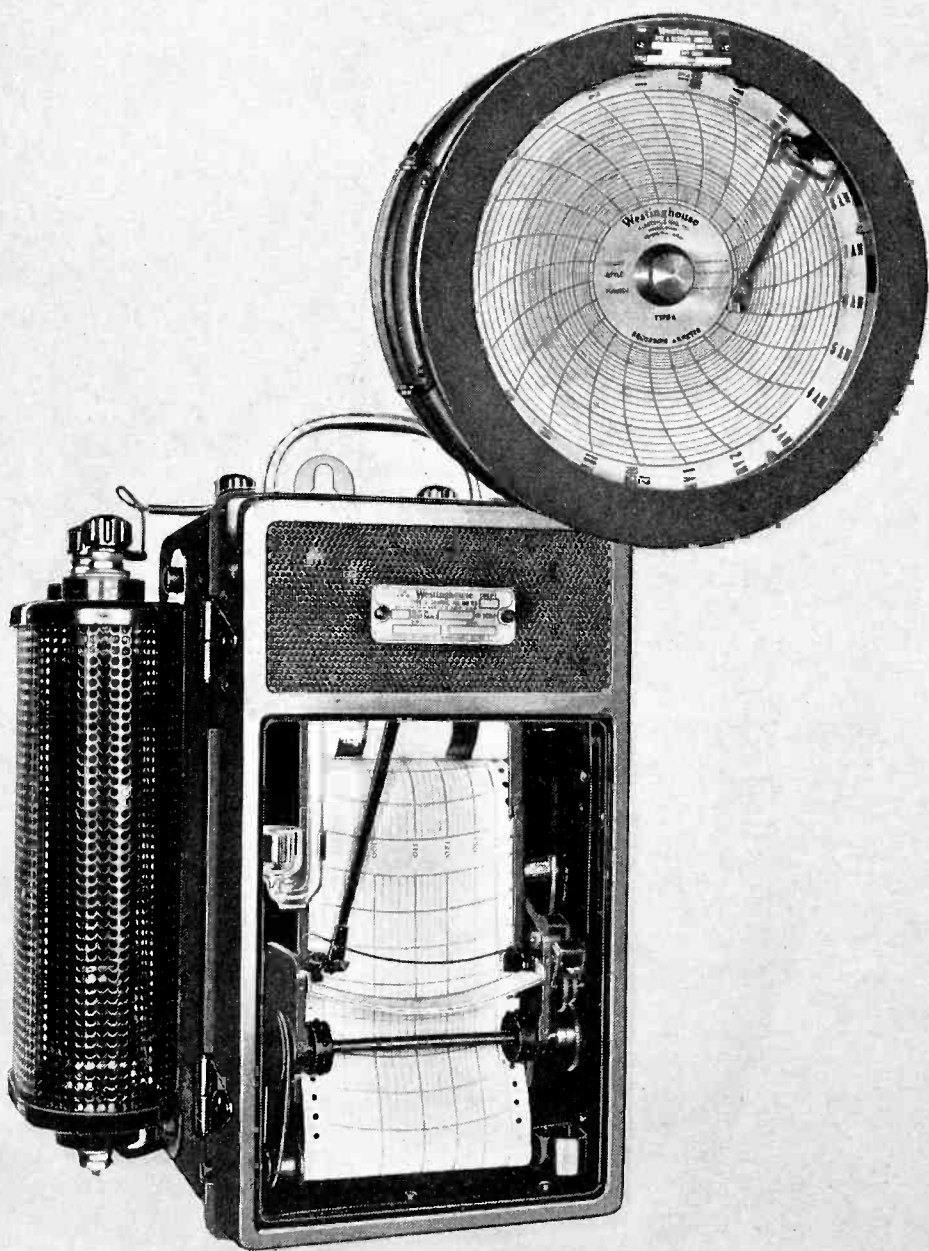

TYPE A

Circular chart models for 1, 3, or 7-day records—synchronous or 8-day clock, a-c or d-c, portable or switchboard. Ideal for survey and process control. Direct acting—simple, sturdy construction. Accuracy within 3%.

TYPE U

Economical strip chart recording ammeters and voltmeters for 8-day charts. Synchronous or 8-day clock, chart speeds of 1 or 2 inches per hour, portable or switchboard, a-c or d-c. Also for survey and process control. Light in weight, strongly built, positive acting. Accuracy within 3%.

Westinghouse

RECORDING FACTS

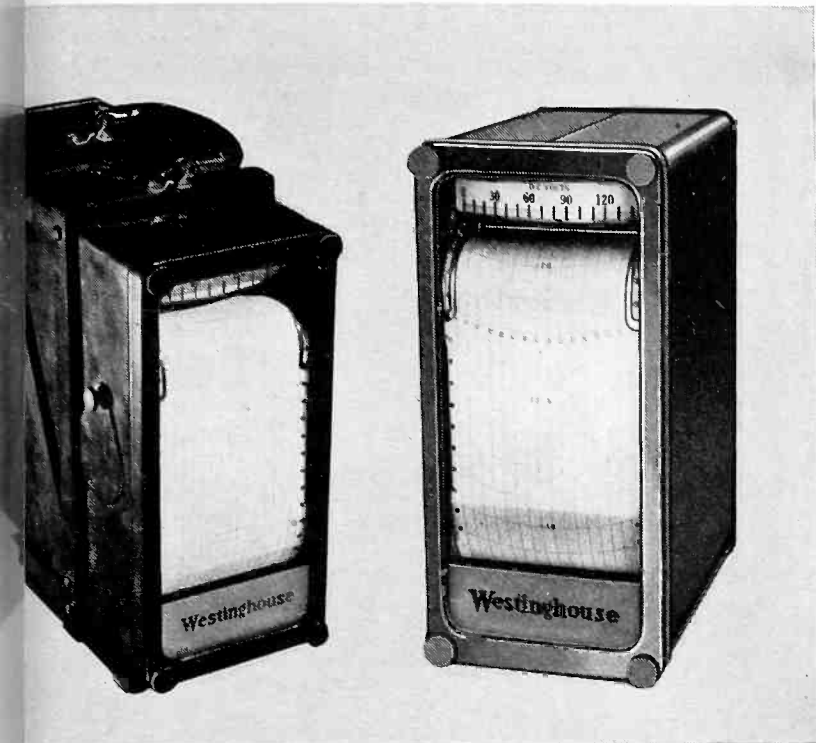

TYPE G

Strip chart voltmeters, ammeters, wattmeters and varmeters for recording minute values on 35, 17, 8 or 3-day charts at speeds of $\frac{3}{4}$, $1\frac{1}{2}$, 3 and 6 inches per minute or hour. Portable or switchboard. For power plants and general applications where long and high precision records are required. Accuracy within 1%.

Save Money by using Recording Instruments with NEW Westinghouse Sockets

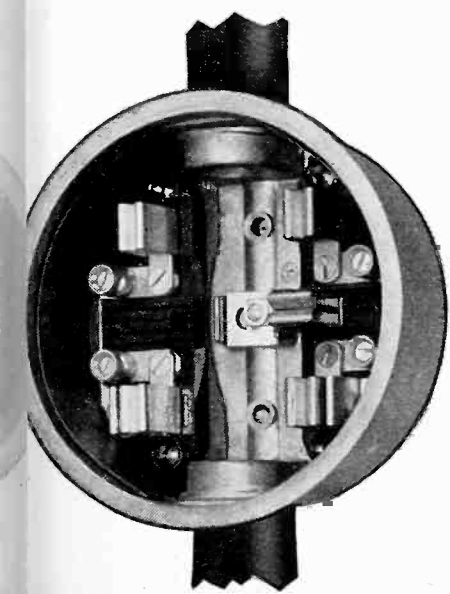

Install these inexpensive sockets on any machine, and, with the use of the test jack, you are ready to plug in recording instruments without change of wiring or loss of production time.

This is the quick, low-cost, accurate way to get operating facts continuously, or to make periodic checks on any machine or electrical circuit. Sockets cost little—to buy or install.

WESTINGHOUSE COMPLETE ELECTRICAL ANALYSIS SYSTEM

Through the use of Westinghouse sockets and the complete line of plug-in instruments, or the industrial analyzer and test jack, you can secure all data necessary for checking performance, trouble-shooting and product development.

J-40231

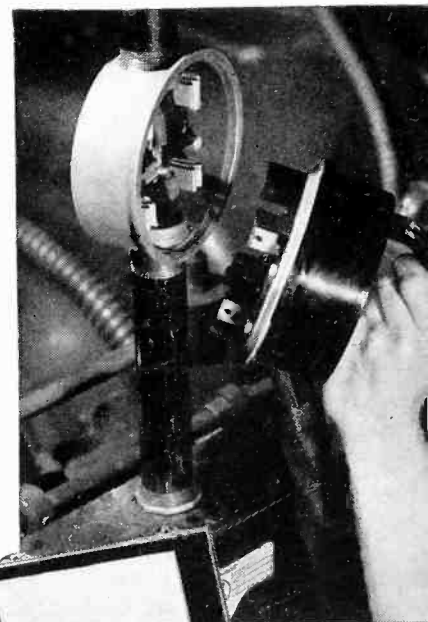

Westinghouse men are ready to help you. Send for Booklet 2136 on Socket Instruments and Booklet 2219 on the Westinghouse System of Electrical Analysis. Write to Westinghouse Electric & Manufacturing Co., East Pittsburgh, Pa., Dept. 7-N.

Instruments



PROGRAM

ROCHESTER FALL MEETING

SAGAMORE HOTEL, ROCHESTER, N. Y.

November 13, 14, 15, 1939

MONDAY, NOVEMBER 13

8:30 A. M.

Registration

9:00 A. M.

Inspection of Exhibits

9:30 A. M.—12:30—NOON

Technical Session
Spectral Response of Phototube to New Illuminants, A. M. Glover, RCA Mfg. Co., Radiotron Division.
Observations on Coverage with Frequency Modulated Waves, Paul A. De Mars, Yankee Network.
A Noise Meter for Television Frequencies, C. J. Franks, Microvolts, Incorporated.

12:30 P. M.

Group Luncheon—Main Dining Room.

2:00 P. M.—4:00 P. M.

Technical Session
Circuit Consideration of Superhetrodyne Converter Tubes, C. R. Hammond and E. Kohler, Jr., Ken-Rad Tube & Lamp Corporation.
The Use of Cascade Circuits with Staggered Parameters for Obtaining Ideal Filter Characteristics, V. D. Landon, RCA Mfg. Co., Victor Division.

4:00 P. M.

Inspection of Exhibits
Meeting—IRE Electronics Committee—Parlor C.
Meeting—RMA Committee on Broadcast Receivers—Green Room A.

6:30 P. M.—8:00 P. M.

Group Dinner—Main Dining Room.

7:30 P. M.

Inspection of Exhibits

8:00 P. M.

Technical Session
What Do We Do Next?, Kenneth Jarvis, Consulting Engineer.

TUESDAY, NOVEMBER 14

9:00 A. M.

Registration
Inspection of Exhibits

9:30 A. M.—12:30—NOON

Technical Session
Annual Message of RMA Director of Engineering, W. R. G. Baker.
A Survey of Standard Signal Generators, E. Karplus, General Radio Company.

12:30 P. M.

Group Luncheon—Main Dining Room.

2:00 P. M.—4:00 P. M.

Technical Session
Some Factors Governing Choice of Lenses for Television Cameras, H. B. DeVore and Harley Iams, RCA Mfg. Co., Radiotron Division.
A Demonstration of Audio-Frequency Testing with Square Waves, L. B. Arguimbau, General Radio Company.
Vacuum Tube Life Probability Versus Consumer Satisfaction, Henry Parker, Rogers Radio Tubes, Ltd.

4:00 P. M.

Inspection of Exhibits

6:30 P. M.—8:00 P. M.

Fall Meeting Dinner (Stag)—Rochester Club.
Toastmaster—A. N. Goldsmith
Speaker—H. B. Richmond
Subject—RMA-IRE Cooperation

WEDNESDAY, NOVEMBER 15

9:00 A. M.

Inspection of Exhibits

9:30 A. M.—12:30—NOON

Technical Session
The Gradation of Television Pictures, H. E. Kallmann.
Tubes for High Frequency Amplification in Receivers, M. A. Acheson and W. P. Mueller, Hygrade Sylvania Corporation.

11:15 A. M.

Inspection Trip, Stromberg-Carlson Frequency Modulated Wave Station, Rochester Gas and Electric Building, (Next Door to Sagamore Hotel).

12:30 P. M.

Group Luncheon—Main Dining Room.

2:00 P. M.—4:00 P. M.

Technical Session
Television Receiving Antennas, Stanford Goldman, General Electric Company.
Progress in Development of Instruments for Measuring Radio Noise, C. M. Burrill, RCA Mfg. Co., Camden, N. J.
Summary of the Significance of the Papers Delivered at this Meeting, D. D. Israel, Emerson Phonograph & Radio Corporation.

4:00 P. M.

Exhibits Close
Meeting—RMA Committee on Television—Green Room A.
Meeting—RMA Committee on Sound Equipment—Parlor A.

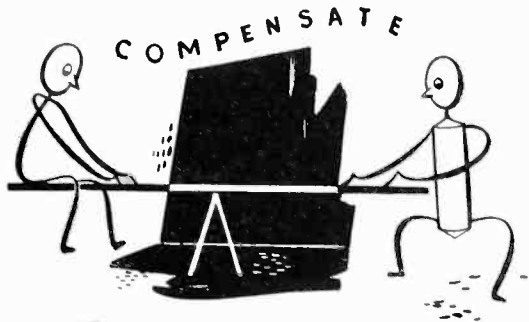

Compensate
 FOR
FREQUENCY DRIFT
 WITH
ERIE CERAMICONS

REG. U.S. PAT. OFF.



Troublesome, performance-ruining frequency drift due to temperature may occur in as many as 6 or 7 different components. Tracking it down and doing away with it in each individual component is usually a long and expensive process. This procedure is unnecessary since, in most cases, an Erie Ceramicon used as part of the capacitive reactance in the oscillator circuit can effectively compensate for the summation of all the individual drifts.

These ceramic-dielectric condensers can be supplied with any desired permanent and reproducible temperature coefficient between $+.00012$ and $-.00068$ per $^{\circ}\text{C}$.

If you will send a chassis and wiring diagram of your set, our engineering department will be glad to show you how simply and efficiently an Erie Ceramicon can remedy this frequency drift.



Eliminate
**CONDENSER
 CAPACITY DRIFT**
 WITH
**ERIE SILVER-MICA
 CONDENSERS**



By using the new molded Type K Erie Silver-Micas in place of ordinary mica condensers in tuned circuits, frequency drift caused by condensers can be eliminated.

The low temperature coefficient of Erie Silver-Micas (0 to $+.00004$ per $^{\circ}\text{C}$, depending on capacity) is unusually stable even under adverse operating conditions. After 5 complete cycles of 5 hours at -30°F and 15 hours at 180°F , capacity change is less than .135%. After 100 hours in 100% relative humidity at 104°F , the capacity will change less than .05%.

Type K molded units are available in ranges from 15 mmf. to 500 mmf. Other types with the same general characteristics are made up to 2500 mmf.

ERIE RESISTOR CORPORATION, Erie, Pa.

TORONTO, CANADA • LONDON, ENGLAND • PARIS, FRANCE - J.E. CANETTI CO.

MANUFACTURERS OF RESISTORS • CONDENSERS • MOLDED PLASTICS

NEW BOOKS

Theory and Application of Electron Tubes

By HERBERT J. REICH, *Associate Professor of Electrical Engineering, University of Illinois. McGraw-Hill Book Co. 670 pages, illustrated. Price \$5.00.*

Professor Reich's book is one of the more recent of the growing texts on electron tubes, and while the field is quite thoroughly written, "Theory and Application of Electron Tubes" does fulfill a useful service. The author states, "The book is intended to give the student a sufficiently thorough ground in the fundamental principles of electron tubes and associated circuits to enable him to apply electron tubes to the solution of new problems. The author has not attempted to discuss all applications of tubes to special problems, but rather to cover basic principles and typical applications. . . . Although written primarily as a text for college students, it is hoped that it will also prove to be of value to practicing engineers as a reference book." Within the confines of these statements, the book fulfills its function admirably.

The chapter headings are: Physical Concepts, Thermionic Emission, Grid Controlled High Vacuum Tubes, Methods of Analysis of Vacuum Tubes and Vacuum Tube Circuits, Modulation and Demodulation, Amplifier Definitions, Classifications and Circuits, Analysis and Design of Voltage and Current Amplifiers, Class A and Class AB1 Power Amplifiers, Class B and AB2 and Class C Amplifiers, Vacuum Tube Oscillators, Electrical Conduction in Gases, Glow and Arc-Discharge Tubes and Circuits, Light Sensitive Tubes and Cells, Power Supplies, Electron Tube Instruments and Measurements. Thus the book covers the usual subjects, as well as some not frequently treated.

The book is definitely intended for engineering students or those having a good foundation in mathematics and physics; it is in no sense of the word a trade school text. Mathematical analysis and graphical methods are extensively employed, but only when they serve a useful purpose. Throughout the book is entirely practical, and where simplified technique can be used to obtain the desired result, this is done. There is a wealth of material presented, and the subjects are logically assembled and co-ordinated. Moreover the book is unusually thorough, especially for one of its size. Each chapter contains a bibliography to which reference may be made for additional data which could not be covered in greater detail in the chapter.

Features of the book, which in the opinion of this reviewer, merit special mention are: (1) the completeness and thoroughness of the treatment of the various classes of amplifiers, including treatment of inverse feedback circuits,

(2) the inclusion of chapters on electrical conduction in gases and glow- and arc-discharge tubes and circuits (although the reviewer feels that greater emphasis might have been placed on the kinetic theory of gases, at least to the extent of including the work of Loeb and Kennard in the bibliography), (3) the extensive treatment of electron tube instruments and measurements, and (4) the use of series expansion methods for analyzing the non-linear operation of tubes and their associated circuits. The book does not discuss the operation of tubes at ultra-high frequencies where transit time of electrons is important, and this seems to be an important omission for a book of this type. The author has eliminated the hackneyed treatment of emission in which both forms of Richardson's equation are given and gets down to brass tacks with the generally accepted equation. Child's equation is hardly adequately derived for the average student, and the treatment does not indicate the physical significance too well. Figure 7-4 is not correctly labelled.

All in all, Professor Reich's text is extremely suitable for the intended purpose. While not as complete in the physics of tubes as other texts, nor as erudite as some, it is, in this reviewer's opinion, the best practical text on electron tubes yet published in English.—B. D.

Principles of Electricity and Magnetism

By GAYLORD P. HARNWELL, *Professor of Physics, University of Pennsylvania. The McGraw-Hill Book Co., New York, 1938. 619 pages, illustrated. Price \$5.00.*

A GREAT MANY books on electricity and magnetism have been written since Maxwell's day. But this book marks a departure from many of its predecessors. For one thing, it establishes the practical system of units in the beginning of the book and adheres firmly to them throughout, thus avoiding much confusion and making easy the transfer from physical theory to engineering applications. The book is practical in other respects, since it draws very simple comparisons before laying down the rigorous treatment, and it pays much more attention than is usual to the modern applications of electricity and magnetism. The chapter on vacuum tubes, for example, includes the cathode-ray oscilloscope which is an item not usually met in texts on physics. A later chapter on vacuum tube circuits includes treatments of amplifiers in classes A, B, and C, as well as of oscillators. None of these treatments is

exhaustive but together they indicate the scope of the book.

The subject is one which apparently cannot be taught without leaning on vector symbolism, but to ease this difficulty a very worthwhile mathematical appendix is included which starts "from scratch."

As a reference book on fundamentals underlying all electrical fields, the book should be very valuable to the engineer and student alike. It must be carefully studied, since the order of presentation is not always convenient and easy to follow, but when studied will reveal the basis of nearly all important electrical phenomena. The chapters include: Electrostatics, Electrostatic Energy and Dielectrics, Characteristics of Dielectrics and Conductors, D-C Circuits, Non-ohmic Circuits and A-C, Chemical Thermal and Photoelectrical Effects, Vacuum Tubes, Gas Conduction, Electromagnetic Effects, Electromagnetic Reactions, Magnetic Properties, Electric Machinery, Circuits of R, C and L, Coupled Circuits and Lines, Tube Circuits, and Radiation.—D.G.F.

• • •

Radio and Instrument Flying

By KARL S. DAY, *Assistant Flight Superintendent, American Airlines. Air Associates, Inc., Garden City, N. Y., 1938, 284 pages, illustrated.*

THIS IS A PRACTICAL BOOK which describes in detail the procedures used by pilots in navigating aircraft by the correlation of radio and other instruments. For the student of radio-aided flight the book should be very worth while. For the engineer its main interest is as an object lesson to be borne in mind when designing aircraft radio equipment. Engineers, having read this book, will have more sympathy with the pilot's demand that radio equipment be simple and reliable and that the indicating instruments be coordinated as much as possible with other flight instruments.—D.G.F.

TWO-WAY TELEVISION



Temporary television studio, recently set up in the Ambassador Hotel at Atlantic City, to demonstrate two-way high-definition television. The viewer watches the image of a friend on another floor of the hotel in the receiver before him, while the television camera picks up his image from a similar receiver

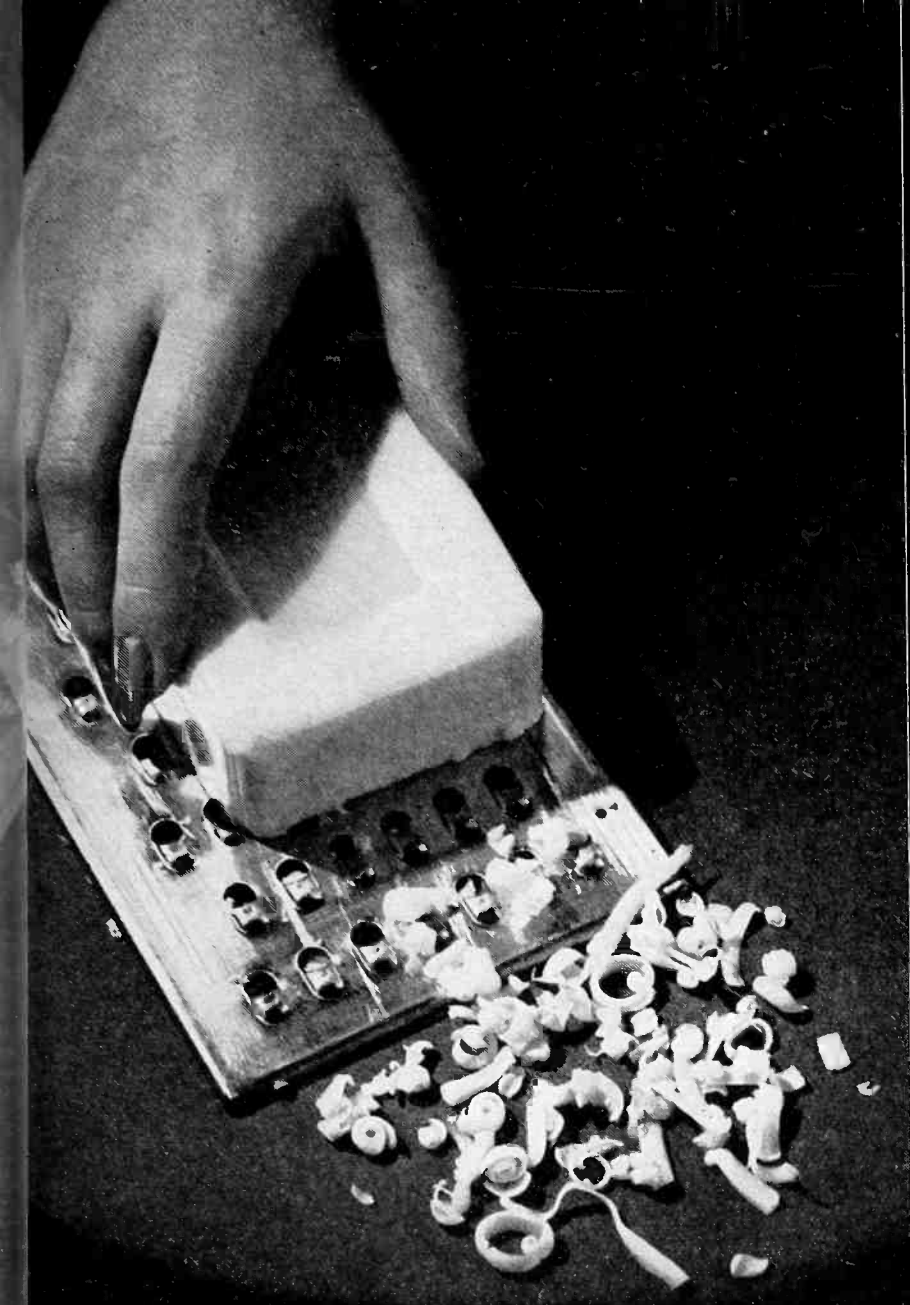

You can make soap chips or buy them ready-to-use—but..

... in buying technical plastics, as in buying soap chips, ready-to-use is often more satisfactory

You could shave your own soap chips, but with many economical, ready-to-use chips on the market, it sometimes isn't worth your time, trouble and expense.

There is a possibility that in your shop, equally valuable time and money may be wasted in fabricating parts that can be bought more profitably from us—and ready-to-use. For two good reasons:

First: Synthane Technical Plastics have many properties *in combination*. Their selection, in place of another material, generally gives you initial advantages in weight reduction, corrosion resistance, machinability, and numerous other physical, chemical, mechanical and electrical characteristics.

Second: You gain—usually—by letting our machine parts for you. You relieve yourself of the responsibility for mistakes in machin-

ing, for rejects, and delays in delivery. You benefit from our experience in newer, faster ways of machining Synthane. We make properly the dies, jigs, and fixtures for machining technical plastics. You also save the capital investment in machine tools if the present equipment of your shop is not well suited for the fabrication of Synthane exclusively.

If your production requirements justify the installation and maintenance of special machines then do your own machining. We'll supply your sheets, rods and tubes.

At the left are parts machined from Synthane by us for three widely different manufacturers. We believe you, too, will find Synthane materials and machining well worth looking into. Why not send in your application today?

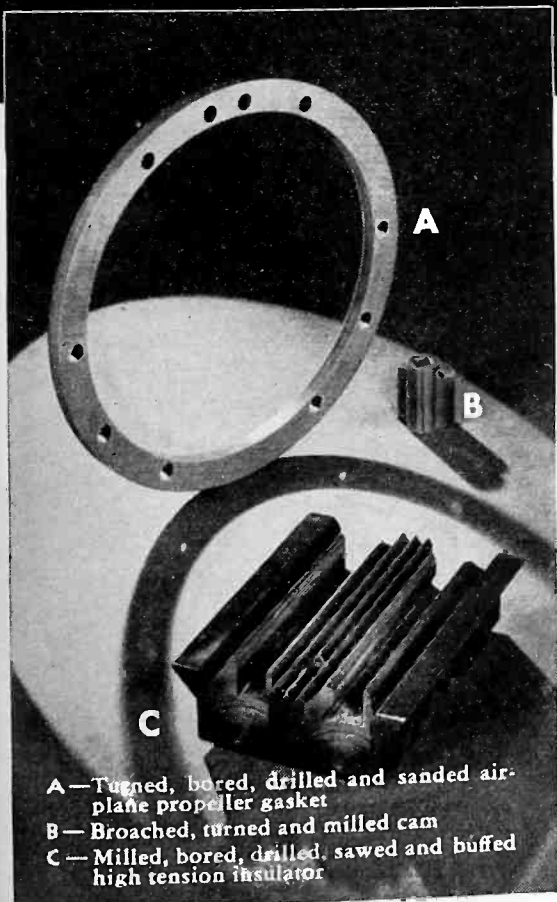

A—Turned, bored, drilled and sanded airplane propeller gasket
 B—Broached, turned and milled cam
 C—Milled, bored, drilled, sawed and buffed high tension insulator

SHEETS • RODS • TUBES • FABRICATED PARTS • SILENT STABILIZED GEAR MATERIAL

SYNTHANE

...ION OAKS PENNSYLVANIA

TUBES AT WORK

AMONG the applications this month are a compact photoelectric colorimeter, a new method of high voltage testing, water-cooled television lamps, and an oscilloscope motor-tester

Trough-Type Colorimeter Uses Self Generating Cell

AN EXTREMELY RELIABLE colorimeter based upon the photoelectric cell has been developed by Le Materiel Telephonique, associated company in France of the International Telephone and Telegraph Corporation, and is expected to have wide application in the food preparation and chemical industries, in such processes as the manufacture of sugar, spirits, paper, etc. Extensive tests demonstrate that the new instrument performs delicate color comparisons rapidly and with much greater consistency than methods which depend upon the judgment of the human eye.

Its speed of manipulation, robustness and simplicity allow the use of non-expert labor in processes hitherto requiring delicate visual judgment. The equipment is also suitable for the determination of the pH value (or hydrogen ion concentration) of a liquid solution.

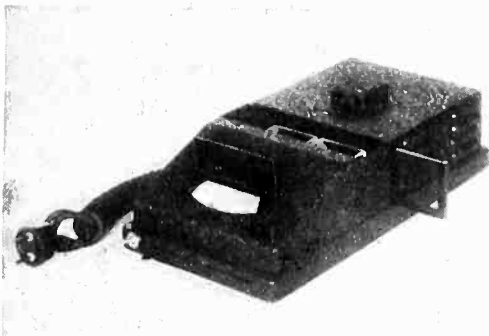

L.M.T. trough-type colorimeter

The principle of the colorimetric determination consists in passing light from an electric lamp through the liquid under examination and measuring the resulting current produced in a photoelectric cell placed on the other side of the liquid. The colorimeter therefore consists of the following essential parts, in order of position: an electric lamp to supply the light rays, an optical system of suitable lenses, a diaphragm for regulating the amount of light traversing the liquid, a filter support to carry suitable colored filters which may be interposed in the light track, a movable shelf to carry the glass troughs for the reference liquid and for the liquid under comparison, the photoelectric cell and a microammeter.

Two glass troughs, one filled with a reference liquid and the other with liquid to be examined, are placed side by side on the movable shelf and a suitable light filter may be placed in position. Light from the source is controlled by the switch on the front edge of the colorimeter (see photograph below) and the lever, also in front, is operated to permit interception of the light ray by the reference trough.

The quantity of light received by the photoelectric cell is regulated by means of the diaphragm until the needle of the microammeter is on a mark sensibly in the center of the scale, and the deflection is noted. The lever is then operated to bring the trough of the liquid under test into the position of the light ray and a new deflection is obtained which characterizes the color or opacity of the liquid preparation being analyzed.

For standardizing and rapid comparison of samples, it would be possible to calibrate the apparatus for a given coloring matter by putting as abscissae the pH value of the solution and as ordinates the corresponding deflections. From the curve thus obtained the pH value of the solution can be read off against a particular deflection obtained.

Glass troughs of 20 mm and 40 mm thickness are used, the former where the liquid is sufficiently colored to give an effective deflection with that thickness but in cases where liquids to be analyzed are only faintly colored, or where it is necessary to stir the liquid, 40 mm troughs would be employed.

A system of four 20 mm troughs would be employed in all cases of colorimetric measurements of pH, for example, in cases in which the power of the luminous transmission of the liquid to be studied may be different from that of distilled water which is a constituent of the reference trough.

The parts described are enclosed in a pressed metal case, of which the dimensions are: length, 11 inches; width, 6.7 inches; height, 3.75 inches.

• • •

High Voltage Testing at Low Power

AT THE SHARON, Pennsylvania works of the Westinghouse Company, equipment has been installed for the testing of distribution transformers, and other

equipment exposed to lightning hazards, under conditions simulating an actual stroke of lightning. Lightning strokes possess enormous energy, and hence it is impractical to provide equipment capable of imitating the lightning stroke exactly, but it is quite possible to imitate its effects with equipment possessing low energy storage. In actual lightning the high voltage and high current exist simultaneously and hence the power represented by their product is very great. In the Sharon Works equipment, the high voltage and the high current are provided by two separate generators which act in succession. Thus the voltage impulse is generated in a rectifier circuit which charges a bank of small capacitors in

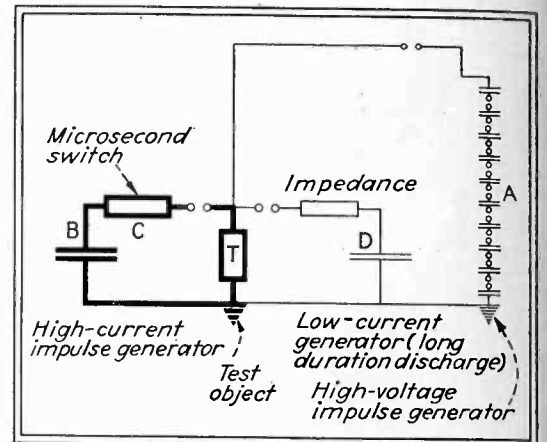

Circuit for separating current and voltage surges

parallel. The capacitors are then discharged in series, so that a total voltage in the millions of volts is developed, but at very low current, representing the expenditure of a small

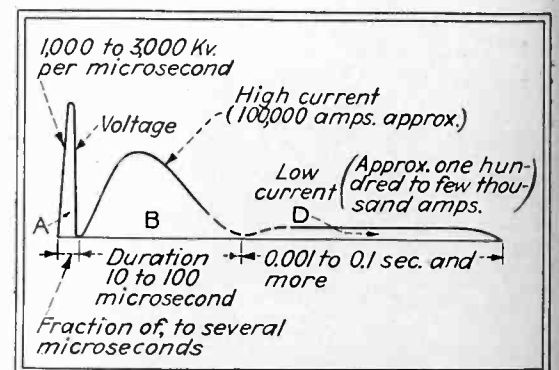

Successive current and voltage waves

amount of energy. Similarly the heavy current stroke is produced by charging a capacitor of high capacitance at low voltage and discharging it through the path established by the high voltage stroke. Considerable energy is consumed in the current stroke, but it is available at low voltage.

The circuit arrangement of the test equipment is shown in the figure. The object to be tested, T, is connected between ground and the high voltage tester A and also to two current generators, one having a high current for a small duration, the other a small current for a longer duration. When



HIGH accuracy



BROAD flexibility

WESTON Current Transformers

MODEL 461 (TYPE 2)

Broad flexibility plus accuracy for routine current testing. Ranges . . . 10/20/50/100 Amperes self contained Primary; maximum of 800 amperes with Inserted Primary.

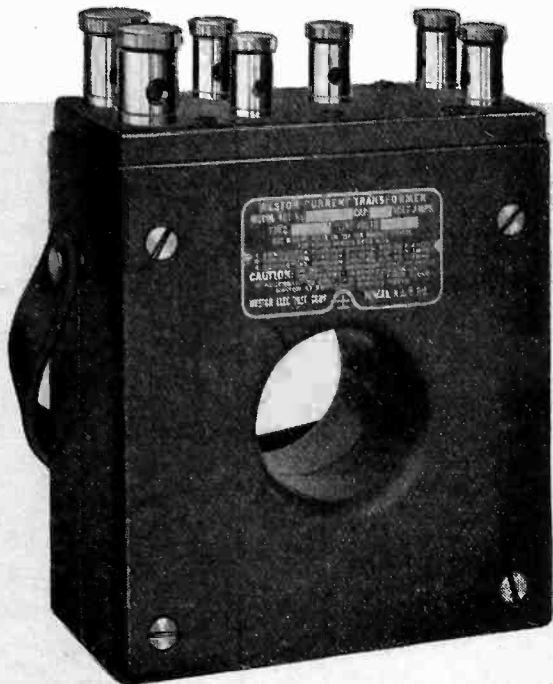

TYPICAL ACCURACY CURVES

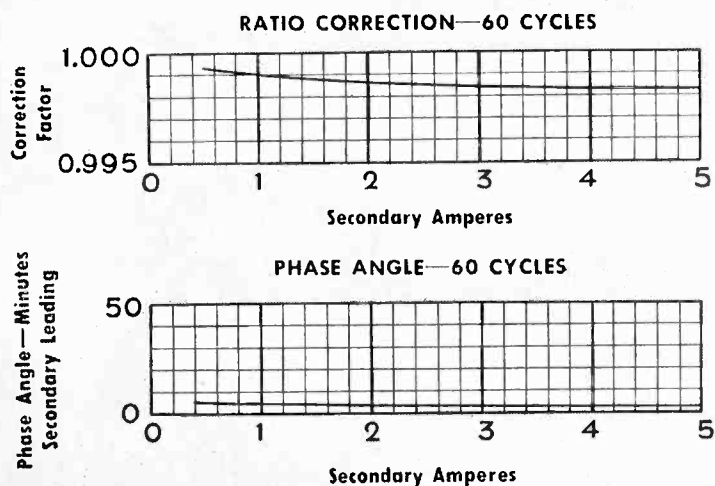

MODEL 327 (TYPE 2)

Extreme accuracy plus flexibility for certification work. Ranges: 10/20/50/100 Amperes at binding posts; and 200/300/400/600/1200 Amperes with Inserted Primary.

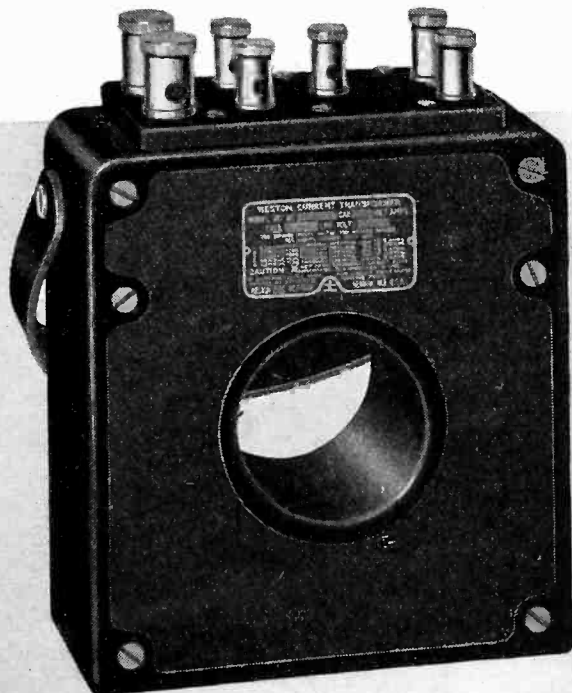

TYPICAL ACCURACY CURVES

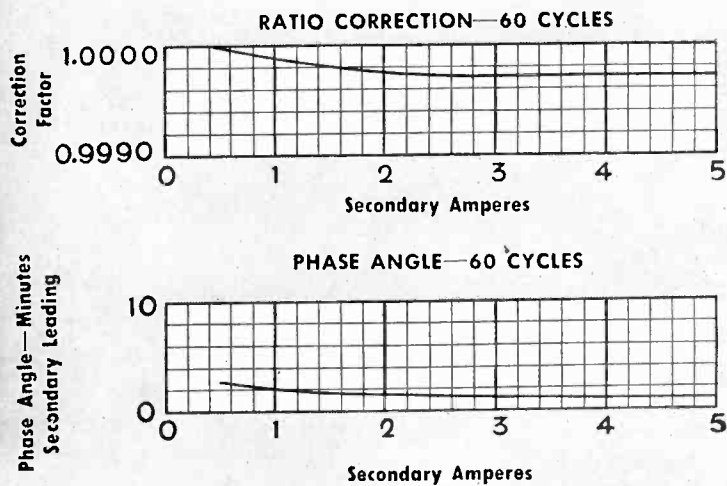

Complete details on these and other WESTON portable Current and Potential Transformers for laboratory and commercial testing are available in bulletin form. Send for your copy.

WESTON ELECTRICAL INSTRUMENT CORP., 618 FRELINGHUYSEN AVENUE, NEWARK, N. J.

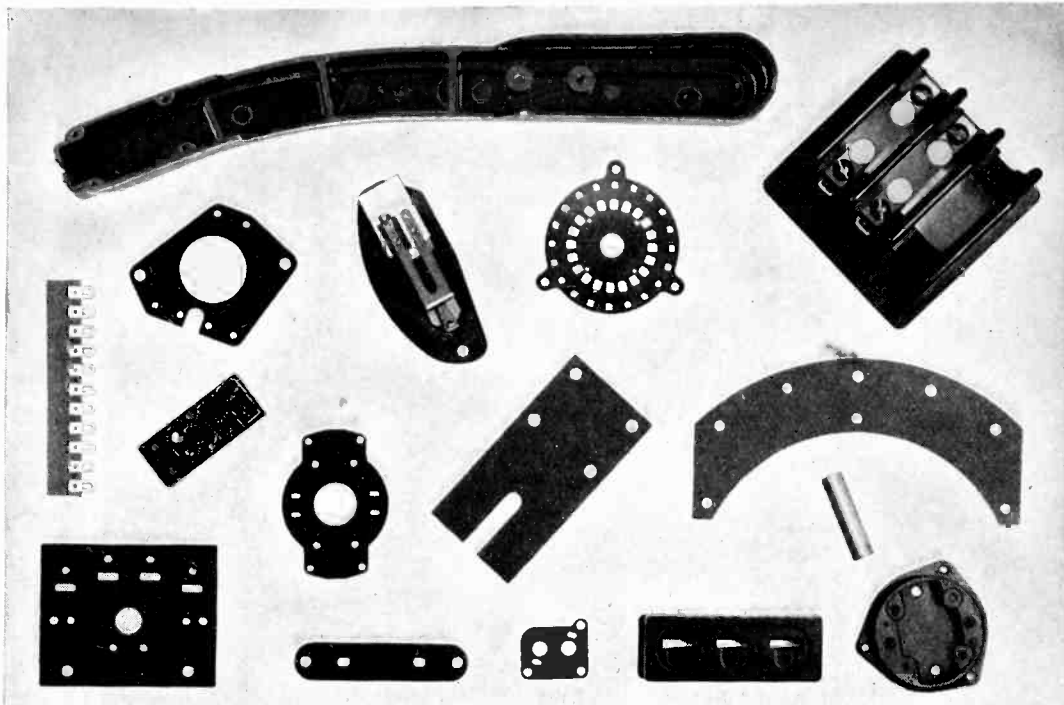

RICHARDSON

Precision

PLASTICS

All Richardson parts and products are precision fabricated to meet definite specifications and close tolerances. But more than that: the *plastics themselves* possess precision qualities.

INSUROK

LAMINATED AND MOLDED

INSUROK, the *precision plastic*, is produced under exacting technical control from inspection of the raw material to final approval of the finished product. It is constant in its physical, chemical and dielectric characteristics. It serves its particular use with fidelity, and gives a generous surplus in value and performance. For electrical parts . . . a seemingly unimportant punching to the most intricate precision molding . . . INSUROK offers many profitable production advantages. To finished products it adds priceless qualities that build good will, prestige and increased sales. Literature on request.

The **RICHARDSON COMPANY**

Melrose Park, (Chicago) Ill. Founded 1858 Lockland, (Cincinnati) Ohio
 New Brunswick, N. J. Indianapolis, Ind.
 Detroit Office: 4-252 G. M. Building, Phone Madison 9386
 New York Office: 75 West Street, Phone Whitehall 3-4487

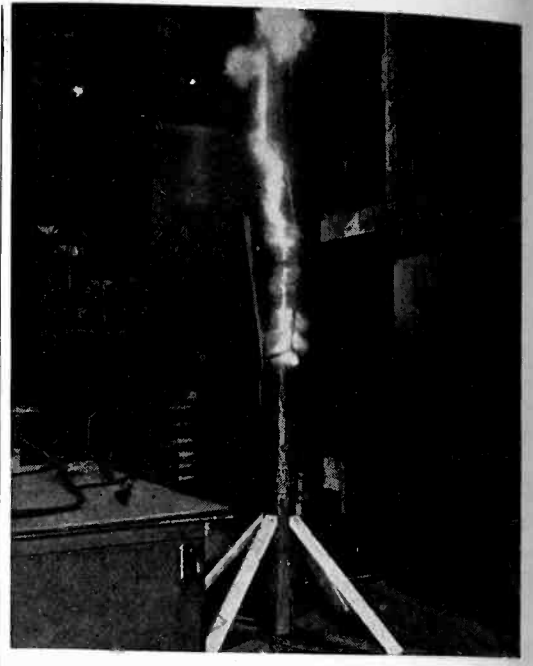

Surge equipment in action on telephone pole

the high voltage generator discharges, the microsecond switch in series with the high current generator allows the high current discharge to follow within one microsecond or less, and this is then followed by the low current discharge which may last for a 0.1 second or longer. The succession of discharges is shown in graphical form in the accompanying plot.

The initial high voltage discharge breaks down the discharge path and bridges the gap over the test object. The ionization in the discharge path then persists long enough to allow the high current impulse to follow immediately. This high current discharge does most of the actual damage. Finally the low current discharge follows the same path. The photograph shows a typical discharge produced on a telegraph pole. The effect was severe enough to shatter the pole in very much the same manner as if it had been struck by lightning.

. . .

Communications Equipment for Disaster Service

THE EDITORS ARE indebted to G. W. Sloat, Radio Electrician of the Portland Oregon Fire Department, for information on the radio equipment of an unusual disaster service truck in use by that Department. The truck was designed by Aaron M. Frank and donated by him to the Department. In all it contains about 1,000 pieces of rescue and disaster-service equipment suitable to meet almost any conceivable emergency. Besides portable power generating plants, lights and cables, complete radio and public address equipment, the truck contains first aid equipment, oxygen breathing apparatus, resuscitator, inhalator, respirator, complete kit of surgical instruments, acetylene torch, an outboard motor, binoculars and a 16-mm movie camera.

Statistics!

THE business curve in the Electronics field is up—and will continue to climb sharply.

The advertising income of Electronics is up—advertisers have invested more dollars in Electronics advertising space during the first 10 months of 1939 than any other similar period in the publication's history.

This means that more manufacturers are making greater use of the advertising pages of Electronics *to make sales—to reach those important men* (often inaccessible to salesmen) *who buy or influence purchases.*

Your sales message in the November issue will reach your potential customers at the height of the buying season. It will also have wide distribution at the November Rochester meeting of the I.R.E. where engineers, alert to technical progress, are looking for the answers which you may supply.

Make sure that you have *sales representation* in November Electronics. Advertising forms close October 31.

PROVED RIGHT!

in HUNDREDS of THOUSANDS of Electronic, Radio and Industrial Installations

Just check the performance-record of Ohmite units—you'll see why they're first choice in so many electronic, radio and industrial installations. Their long, trouble-free service in the control of light, heat, speed and power — their ability to stand up under shock, vibration, heat and humidity — have proved their complete reliability and economy. In the extensive range of Ohmite stock types, sizes and ratings, you can often find the quick, economical solution you seek — or Ohmite Engineers, with their wide experience, will be glad to cooperate with you in designing the best unit for your specific need.

OHMITE

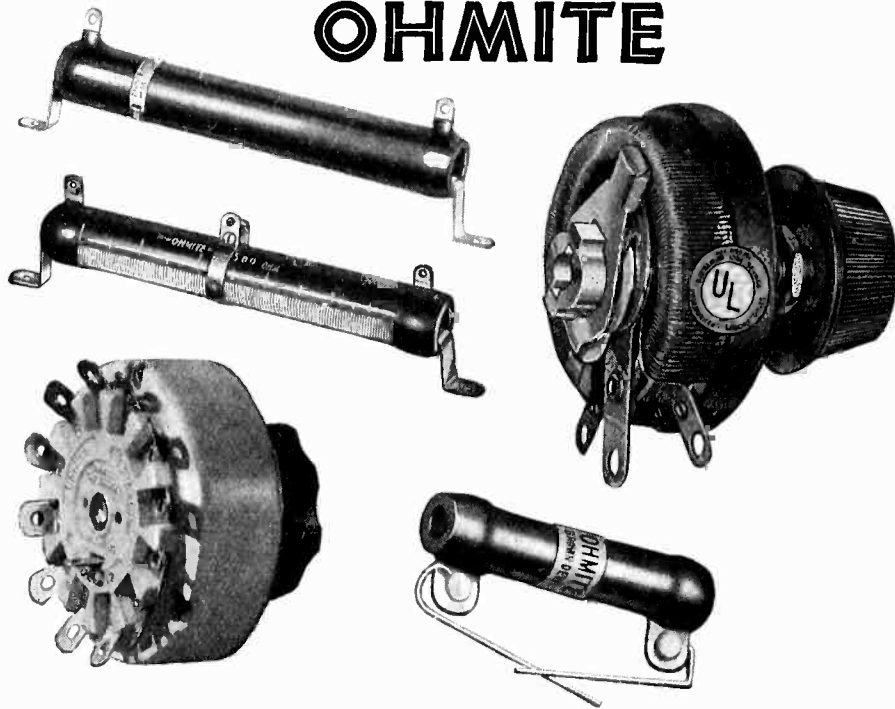

STOCK or SPECIAL UNITS for YOUR EXACT NEED

OHMITE RHEOSTATS are unequalled for permanently smooth, gradual, close control. All-porcelain vitreous enamel construction — nothing to smoke, char, shrink or shift. 9 sizes from 25 to 1000 watts. ★ OHMITE RESISTORS are accurately wire-wound and permanently protected by Ohmite Vitreous

Enamel. Available in Fixed or Adjustable, Regular or Non-Inductive, General-Purpose or Precision types. ★ OHMITE NEW TAP SWITCHES bring new efficiency to high current circuit switching. All-enclosed ceramic construction, with silver-to-silver contacts and "slow-break" quick-make action. Four sizes from 10 to 75 amperes, 240 V.A.C.

Put Your Problem up to Ohmite — or Send Today for Catalog 17.

OHMITE MANUFACTURING COMPANY ★ ★ ★
4816 Flournoy Street ★ Chicago, Illinois, U. S. A.

Be Right with **OHMITE**
RHEOSTATS ★ RESISTORS ★ TAP SWITCHES

Stretchers, tents, linesman's gloves, clothing, cots, jacks, chains, and tools are but a part of the auxiliary equipment.

The communications system consists of a public address system of 200 watts audio power, with a quadruple loudspeaker unit which mounts flush with the top of the car when not in use but which when raised can be swiveled in any direction and turned up or down. The radio transmitter operates with 100 watts power on the u-h-f fire and police emergency band. The antenna is raised from the roof by the action of a compressed air lift. The radio receiver tunes from 520 to 40,000 kc. A complete portable radio receiver and transmitter system is also available. The microphone used with this portable unit is waterproof and may be fitted into a gas-mask. The portable transmitter is crystal controlled to the same frequency as that of the main car transmitter. The portable equipment is intended for communication from within a burning building to the truck, but it is powerful enough for communication as far away as 15 miles direct from the man carrying the unit.

• • •

Cathode-ray Polar Diagram Indicator

AN AUTOMATIC INDICATOR to draw Nyquist polar diagrams, showing magnitude and phase with relation to frequency in a circuit, has been developed by the Central Laboratories maintained by the International Telephone and Telegraph Corporation in Paris. The equipment has been designed on a new basis, and being entirely automatic, it is only necessary to operate a switch to cause the spot of a cathode-ray oscillograph to draw

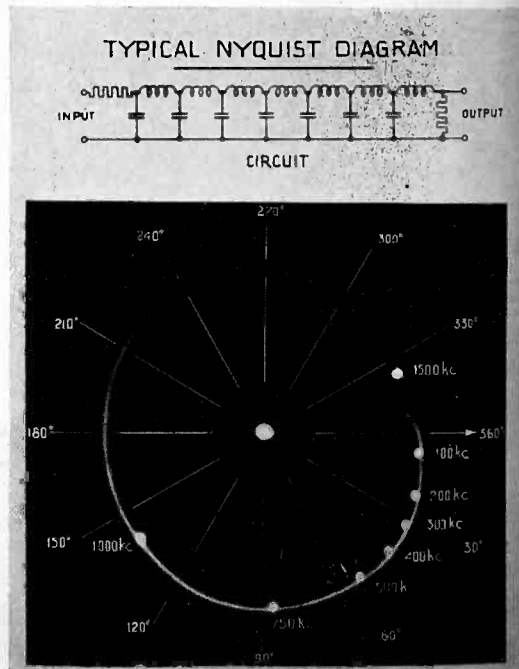

Amplitude and phase characteristics on c-r indicator

the diagram. The diagram can be traced at different rates, corresponding to a spot velocity of 1 inch to 10 inches per second, and with a photographic system coupled to the oscillograph, it is possible to take a photograph of the diagram.

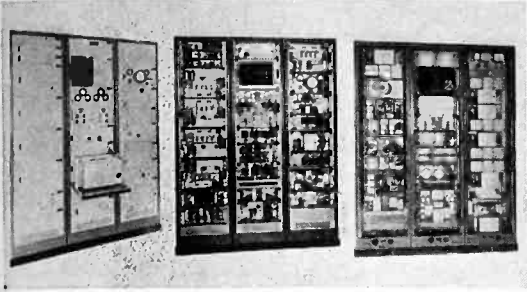

Equipment for generating Nyquist diagrams

The equipment operates between 60 kc and 4000 kc and is applicable to the study of repeaters, filters, transformers, artificial lines and, generally speaking, of any electrical quadripole. It was developed in connection with research on amplification, attenuation and investigation of phase shift variations versus frequency, in laboratory work on repeaters, and circuits applicable to television and transmission by coaxial cables. The complete unit is mounted on three bays: power supply, wattmeter, and oscillator.

• • •

Oscilloscope Used for Checking Speed of Small Motors

THE DETERMINATION of the speed of small motors at no load is made difficult by the fact that conventional tachometers consume sufficient power to obviate the no-load condition. Stroboscopic methods may be used but they call for poor lighting at the work bench, and some skill is required on the part of the operator. Recently a simple direct reading system was devised by the Clough Brengle Company for a manufacturer of fractional horsepower motors. The system is shown in the accompanying sketch. The motor to

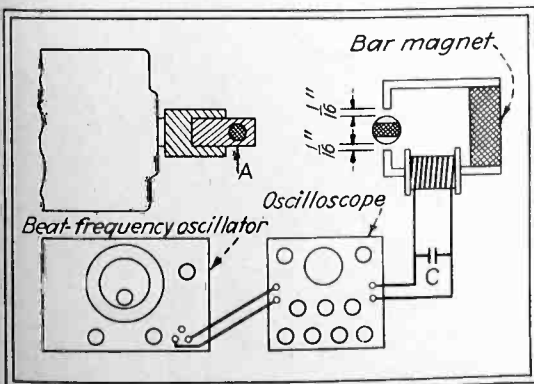

Set-up for measuring speed of small motors

be tested is held in a small cradle, with a quick-release bar which permits rapid handling. A small fitting, A in the dia-

FREQUENCY MODULATION ON THE YANKEE NETWORK

Of Course it's a Success!



"... Eimac tubes give unexcelled performance and long life" ... says Mr. Paul DeMars, technical director for the Yankee Network.

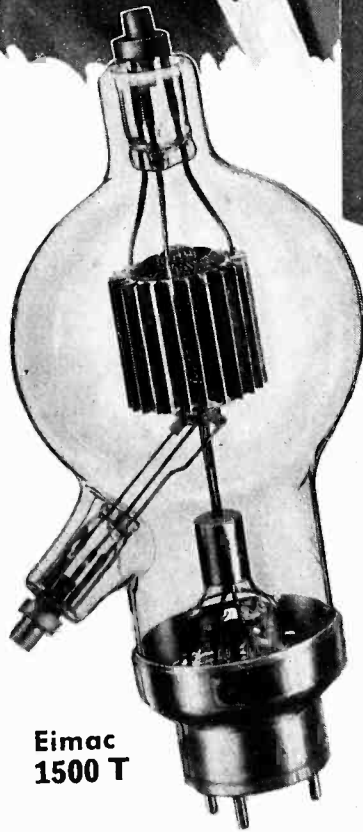
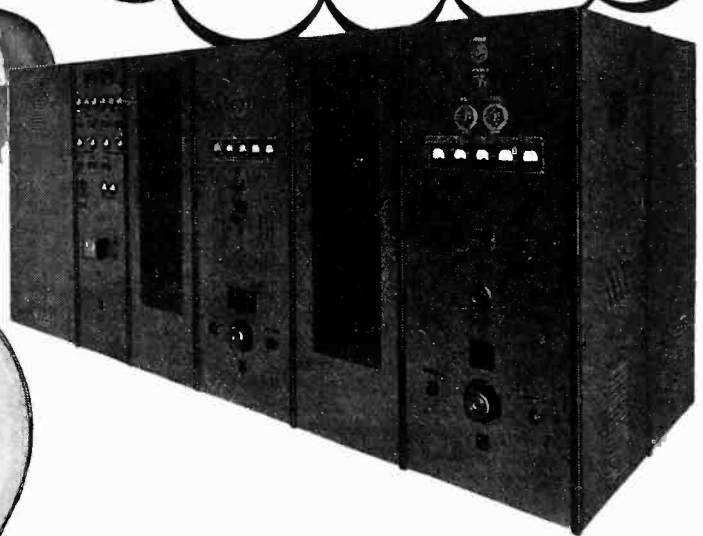

Eimac 1500 T

Eimac
TUBES

Eitel-McCullough, Inc.
788 San Mateo Ave.
San Bruno, California

Skeptics said it wouldn't work but Mr. Paul DeMars (technical director for the Yankee Network) believed in Major Armstrong's system of Frequency Modulation. Through the farsightedness of Mr. DeMars and the cooperation of Mr. Shepherd (owner) this remarkable achievement in Broadcast transmission has become a reality.

No engineer, pioneering in this field, could afford to risk the possibility of failure through the use of inferior equipment . . . every part must be fully dependable and capable of rendering superior performance, not only in the finished transmitter but all through its experimental stages.

It is significant to note that Eimac tubes occupy the important sockets of the Frequency Modulation at WEOD and the High Frequency Broadcast station W1XOJ, now in service on the Yankee Network.

One more proof that: In the important new developments it's Eimac tubes every time.



INDUSTRIAL RECTIFIERS

Tube and disc type rectifiers are the ideal means for converting A.C. to D.C. They are noise and maintenance free and more efficient than rotating equipment. UTC rectifiers are designed to customers' specifications, and are inexpensive, whether in large quantities or single lots. Write for quotations on equipment for your needs.

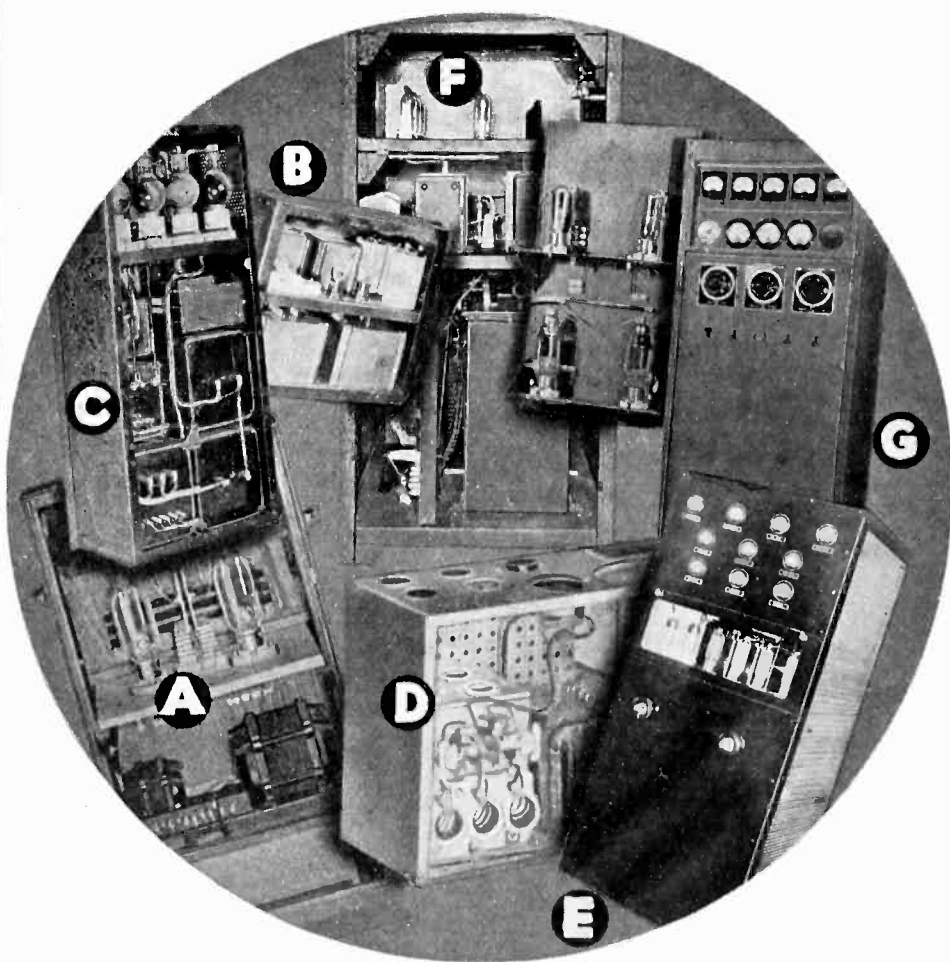

UTC industrial rectifiers are available from 1 volt to 250,000 volts and from 1 watt to 250 Kw. Typical units are illustrated above.

A—For physiotherapy and medical equipment
B—For filament supply
C—5 Kw. 220 V. supply

D—3 phase 220 V. supply
E—5 Kw. high voltage supply
F—20 Kw. high voltage supply
G—Variable voltage laboratory unit

UNITED TRANSFORMER CORP.

Write: ENGINEERING DIV. ★ 150 VARICK ST. ★ NEW YORK, N. Y.
EXPORT DIVISION: 100 VARICK STREET NEW YORK, N. Y. CABLES: "ARLAB"

gram, is fitted on the motor shaft, and acts as the rotor element of a small a-c generator formed by the magnet whose poles fit over the fitting as shown. The frequency of the a-c generated in the coil surrounding the magnet is directly proportional to the speed of the motor and hence can be used as the basis of a comparison measurement. The output of the coil is connected to the vertical deflection plates of a cathode-ray oscilloscope, while the horizontal plates lead to a beat-frequency oscillator, whose frequency calibration is marked directly in rpm. The beat frequency is adjusted until the pattern formed on the oscilloscope is a simple ellipse, which is the Lissajou figure indicating that the two frequencies are the same. The a-c generator does not produce a true sine-wave but the harmonics introduced may be attenuated by the capacitance C connected across the generator output. The speeds attained are as high as 20,000 rpm, and as low as 5,000 rpm, corresponding to a frequency range (since there are two cycles generated for each turn of the shaft) of from 166 cps to 660 cps, both of which lie well within the usual response range of the equipment used.

• • •

Water-cooled Lighting for Television

ONE OF THE DIFFICULTIES in television studio production is the removal of heat produced by the illuminating lamps. Former practice has involved powerful air-conditioning systems, but even such strong-arm methods have failed to reduce the heat to the point where the performers could be comfortable during extended broadcasts.

One answer to this problem has been evolved by General Electric engineers who have designed an argon-filled high-pressure water-cooled lamp which not only has higher efficiency than the equivalent incandescent lamp, but projects practically no heat at all into the studio. The lamp, shown in the accompanying illustration, contains three quartz-enclosed argon lamps covered with quartz water jackets. Two rubber hoses connect to the lamp housing, one to the water tap at the edge of the

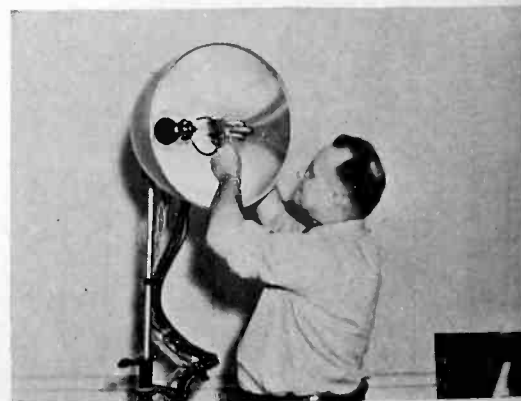

Water-cooled high-pressure argon lamp

studio, the other exhausting to the sewer system. The electrical circuits are equipped with pressure-operated switches and magnetic valves to turn off the water supply and current in the event of low pressure or other failure.



Lamps in use in Schenectady studio

The argon gas operates at a pressure in excess of 1000 pounds per square inch, and generates a light about two and one-thirds as intense, for a given power input, as does the usual incandescent lamp. The heat generated is intense, but about 90 per cent of the heat is conducted away from the lamp by the water system. The total light output of four fixtures containing 12 lamps, is 780,000 lumens, for 12,000 watts input, i.e. the luminous efficiency is about 60 lumens per watt. The water jacket passes virtually all of the visible radiation but impedes most of the infra-red, which has been troublesome in causing sunburn during studio performances.

• • •

Errata

PROFESSOR A. R. NIMS of the Newark College of Engineering has called attention to errors in his article in "Circle Diagrams for Tube Circuits" which appeared in the May, 1939 issue, as follows:

Page 23—Just under the title "Minimum Gain Locus" the numerator of the fraction is omitted. This numerator should be kv^2 .

Page 24—Just under the title "Circle Diagram for Power Output," in the first fractional expression for P_o , there should be brackets in the denominator to indicate that R_p^2 is a factor of the whole denominator.

Page 25—Just above Equation (8) R_o , in the middle expression for P_o , should be changed to R_p as it appears in the third expression for P_o .

At the bottom of the second column on page 25, as well as in the caption of Fig. 3, the wording should be "the angle EOD , which has the same sine as the angle COD ."

Finally on Page 26—at the bottom of the first column the angle, (\angle) is omitted before the symbol COD in the expression for k_r .

Here's a Turntable Worthy
of Today's Quality Reproducers

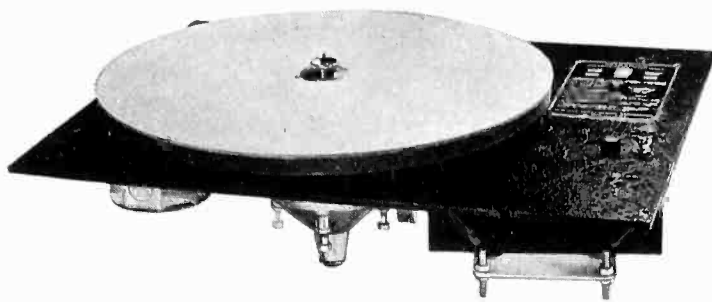

Fairchild Unit 227 Transcription Turntable

The best reproducer in the world won't give you perfect record playing and split-second timing unless your turntable is *absolutely accurate*. Fairchild offers its Unit 227 as the most accurate turntable made.

With Fairchild Unit 227 you can:

1. Change simply from 78 RPM to 33 RPM. You merely shift the push rod on the turntable's center shaft.
2. Play either vertical or lateral cut records up to 16 inches in diameter.
3. Mount various types of reproducers on the panel or on the enclosure in which the turntable itself is mounted.
4. Easily flush mount turntable in a cabinet or desk for permanent studio installations.

Equipment assembled on a 17-inch by 21-inch aluminum panel $\frac{1}{4}$ inch thick finished in black crackle lacquer. A $\frac{1}{50}$ H.P.—1800 RPM synchronous motor drives the turntable through a 2-speed adhesion drive. Turntable made of seasoned cast iron, *dynamically balanced*. Weight 16 pounds. For "wow" free performance gears and worms are ground to an accuracy of less than two parts in ten thousandths of an inch. Equipped with quiet 110-120-volt 60-cycle motor. Floating motor assembly isolates motor vibration from turntable.

Send today for descriptive literature

"... it had to satisfy Fairchild first"



FAIRCHILD

Sound Equipment Division

AERIAL CAMERA CORPORATION
88-06 Van Wyck Boulevard, Jamaica, L. I., N. Y.

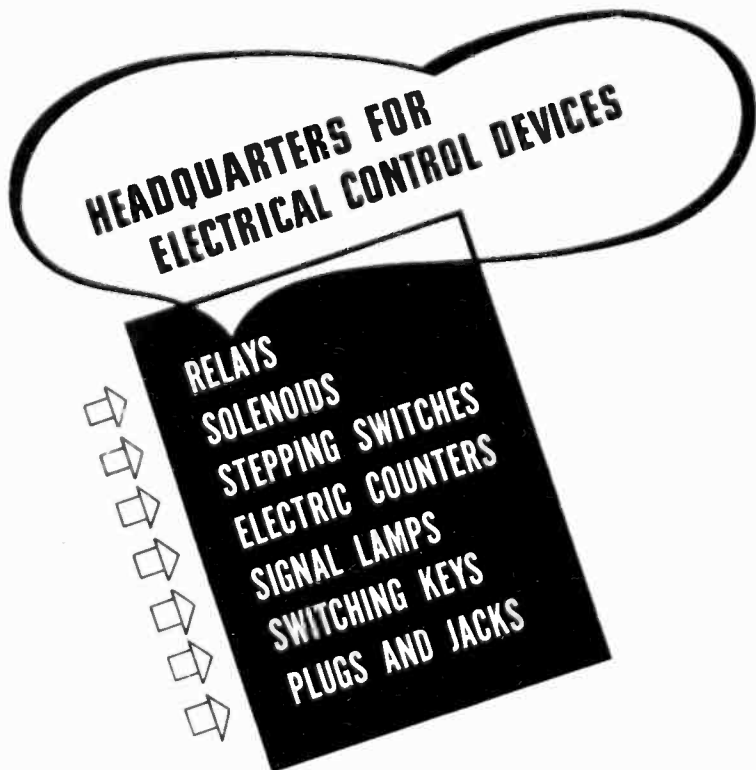

★ For 50 years, we have specialized in the manufacture and application of these devices. May we apply our experience to your problems? American Automatic Electric Sales Co., 1033 W. Van Buren St., Chicago.

AUTOMATIC ELECTRIC

MAKERS OF TELEPHONE AND SIGNALING APPARATUS
ELECTRICAL ENGINEERS, DESIGNERS & CONSULTANTS

GOAT'S HISTORY OF SIGNIFICANT EVENTS—7 IN '99 . . .

The rubber heel was invented . . . a major contribution to walking comfort by "insulating" the wearer against "walking shocks". The Fred Goat Company, now six years old was making major contributions to the machine tool industry through precision equipment.

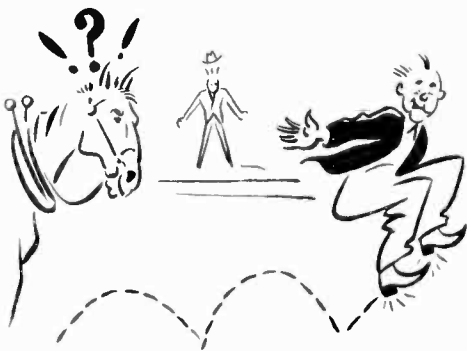

TODAY . . . in 1939

Goat "tailor-made" Radio Tube Shields assure superior performance in millions of sets by insulating them against invisible atmospheric "shocks" that would otherwise interfere with high fidelity reception.



Features

Goat Tube Shields are attractively designed to improve the appearance of your sets . . . and add materially to their "buy" appeal.



GOAT RADIO TUBE PARTS, Inc.
(A DIVISION OF THE FRED GOAT CO., EST. 1893)
314 DEAN STREET, BROOKLYN, N. Y.

Image Dissector

(Continued from page 27)

can readily be accomplished by decreasing the output of the Dissector to zero, which is exactly "black" level. This eliminates the necessity for a separate photo-sensitive pick-up device to integrate the light from the entire optical image and so obtain the requisite background information. Therefore, in this device blanking and background information can be obtained in one operation.

As stated previously, the Dissector tube appears to lend itself ideally to telecine work. The Farnsworth Company has developed a complete telecine channel, including a continuous projector,² utilizing the Dissector tube.

It is true that the Dissector tube is limited in sensitivity but, with the ample illumination which a projection lamp supplies, the signal-to-noise ratio is extremely satisfactory. Freedom from cathode shading and availability of background information warrant its use in such applications where scenes of varying contrast and background are thrown on the cathode in rapid succession.

¹The authors wish to express their appreciation to the Physics Department of Northwestern University for use of their equipment for obtaining these curves.

²See "Electronics", July issue, 1938 and "Journal of the Society of Motion Picture Engineers", Volume XXI, No. 5, November, 1938.

GERMAN TELEVISION RECEIVER

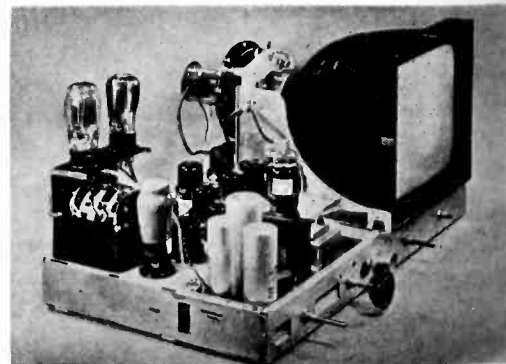

This chassis represents what, a few months ago, represented the most advanced commercial design of German television receivers for the home. The cathode ray tube has a rectangular rather than a circular face. What progress is being made in European television under the present circumstances is, pretty much, anybody's guess

Microphone Polarity

(Continued from page 29)

tion there is a much lower volume to the ear with certain types of program than others. Orchestra pickups generally have about equal peaks in both phases and therefore are restrained to the same extent by full wave and half wave actuated limiters. However, if a singer overrides the orchestra peaks, it is found that amplitudes are greater on one side of the axis than the other. This leads, in the case of a full wave actuated limiter or the half wave actuated limiter incorrectly polarized, to a drop of average level of 2 to 4 db. If the half wave actuated limiter had been reversed in phase, however, the level drop would not have occurred. Furthermore, dramatic scripts originating at the local studios are found to get through the limiters at much lower average levels than those coming over long telephone lines and even lower than the musical portions of the same shows. A properly functioning "transverter" goes a long way towards correcting this.

Another reason for slightly improved results, obtained by phasing for greater upward than downward speech modulation, lies in the radio receiver. Most detectors, even the diode type, generate appreciable distortion on high percentage downward modulation but are distortion free on similar high percentage upward modulation. Thus the average detector distortion is diminished by proper phasing.

The practical value of maintaining correct polarity for maximum upward modulation is obvious. The amount of benefit to be derived is a function of the particular amplifier or transmitters involved, as well as the microphone and individual voice being transmitted. It appears that many existing broadcast transmitters will modulate at least 1 to 3 db higher without distortion if phase is correctly maintained. At the same time when peak limiters are employed, average level ceases to be a function of the dissymmetry of the human voice and the listener is provided with a program of more uniform volume.

IN CINAUDAGRAPH SPEAKERS

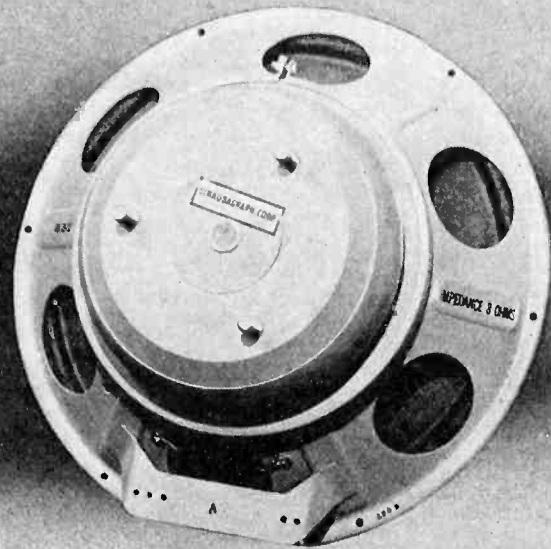

it's what you DON'T SEE that counts most!

If you're any judge of materials and workmanship, you can recognize quality in the Cinaudagraph speaker. But there's more to Cinaudagraph's success than what you see on the surface. Actually, it's what stands behind this complete line of permanent magnet and electrodynamic speakers that counts most. It's the years of research and experiment, of design and assembly and rigid laboratory testing—all performed under one roof by trained engineers expertly supervised every step of the way. *That's* why today, Cinaudagraph is the world's outstanding speaker line.

Profits come biggest where volume sales come quickest. The turnover is rapid on Cinaudagraph speakers because every sale means a 100% satisfied customer. And you know what they say about satisfied customers —"your best advertisement".

There is a Cinaudagraph speaker for every indoor and outdoor job, in both electro-dynamics and permanent magnets from 5" to 27". Send for new catalog today.

CINAUDAGRAPH CORPORATION
STAMFORD • CONNECTICUT

THE ELECTRON ART

Each month the world's technical literature is scanned to see what physicists and engineers are doing with tubes, for presentation to Electronics' readers

Efficient Crystal Oscillator

A PIEZOELECTRIC source of intense ultra-short waves is described in an article by W. W. Salisbury and E. W. Porter under the title, "An Efficient Piezoelectric Oscillator," in the September issue of the *Review of Scientific Instruments*. In the schematic wiring diagram, shown in Fig. 1, a pair of 806 oscillator tubes in parallel are connected in a circuit similar to the shunt-fed Hartley oscillator. The primary oscillator coil is inductively coupled to a secondary coil which feeds power to the piezoelectric crystal immersed in an oil bath. The secondary of this transformer supplies the high frequency voltage directly to the crystal, and is wound with double cotton covered wire on a 3-in. tube.

Since a separate secondary coil is used for each different quartz crystal, no attempt is made for continuously adjusting the frequency of the output circuit. Instead, the secondary coil is adjusted by winding a coil to have a natural frequency somewhat lower than the natural frequency of the crystal. Turns are removed from this coil until optimum activity of the crystal is obtained. The secondary gives a voltage step-up ratio of between 10 and 15, depending upon the frequency.

The quartz crystal rests on a heavy brass plate in an open dish of transformer oil. This brass base acts as one of the condenser plates or electrodes

for applying voltage to the crystal. The circuit oscillates only at the frequency to which the secondary is resonant, and if the secondary coil is removed, the tube oscillates at a higher frequency.

The author states that the mode of operation is superior to an arrangement having a primary and secondary tuned to the same frequency, because it pushes the undesired resonant peaks (which occur when two tuned circuits are closely coupled) so far away that it cannot produce enough grid excitation to give oscillation. This allows the oscillator to put full power into the crystal circuit and into the quartz crystal in a stable condition.

It is stated that more than 40 per cent of the energy applied to the plates of the oscillator tubes is transformed into ultrasonic vibration in an oil bath surrounding the crystal, and as little as 75 watts input power will maintain a continuous fountain of oil 4 centimeters high over a 1-in. square quartz crystal. Approximately one-third of the energy radiated into the oil bath can be transmitted to any liquid in a thin bottom glass vessel. A glass tube having a diameter of 1 in. and closed at one end with a flat glass membrane was placed in the oil bath directly over the quartz plate. It was found that 50 cubic centimeters of water could be heated at the rate of 2° per minute with a plate voltage of 1,200 volts and a plate current of 50 milliamperes.

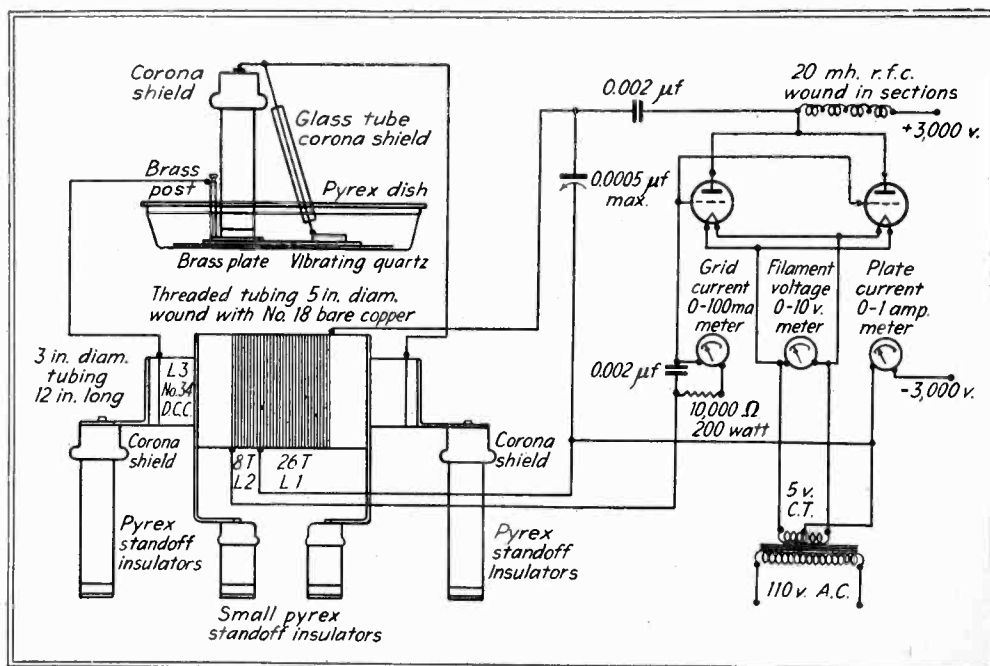

Fig. 1—Schematic wiring diagram of crystal oscillator for generating ultrasonic vibrations in liquids

1939 London Radio Show

THE RADIO SHOW, which was held at Olympia from Aug. 23 to Sept 2, displayed the most recent advances of the British Wireless industry in which all-wave receivers and television receivers played a dominant part, according to the August 24th issue of *The Wireless World*.

Baird Television displayed three main models in different cabinet styles, one of which is combined with a broadcast receiver. All of the screens are viewed directly, or "head on." These models are priced at approximately \$180 to \$220. A. C. Cossor displayed a television receiver using the 15-in. cathode-ray tube arranged for direct viewing, and providing a picture 12 in. wide by 10 in. high. This unit is combined with a three-band broadcast receiver and uses a total of 21 tubes. As is true in the case of some of the Baird receivers, additional gain is employed for those installations in which the television signal strength may be weak. Television receivers with 12-in. cathode-ray tubes were also shown by Dynatron Radio. These receivers are available with television sound equipment only, or in combination with all-wave receivers. One model, using 45 tubes, is an all-wave radio and television receiver with automatic record-changer in the phonograph equipment. Television receivers demonstrated by the General Electric Co. included a model to be used in connection with existing radio receivers as an "add-on unit." The console model using a 9-in. tube provides pictures 6 in. by 7½ in.

Television receivers produced by Scophony are unusual in that they make use of mechanical scanning. The smallest receiver produces a picture approximately 14 x 18 in. The viewing screen is flat and is built as an integral part of the cabinet. Other receivers give pictures approximately 24 in. by 19 in., and 4 ft. by 3½ ft.

A number of innovations were introduced in the field of broadcast radio receivers. Several receivers made use of triode output tubes and many small short-wave receivers were in evidence. Mechanical push-button tuning is utilized extensively. The General Electric Co. showed a wide range of receivers, the majority of the smaller types having a single short-wave band. A mechanical push-button tuning system operates the wave-band switching and there is provision for manual tuning. Receivers designed primarily for overseas use have a range of from 11 to 2,100 meters in five wave-bands. Independent bass and treble tone controls are incorporated in a number of receivers. In a receiver manufactured by the Mullard Wireless Service Co., the push-buttons not only operate the tuning system but also operate the wave-band switch. In this model, as many as six stations are available for push-button tuning, of which three must be medium waves. The British McMurdo Silver Co. displayed a 15-tube receiver of advanced design, combining the sen-

sitivity of the "communication type" receiver with the high quality reception from local stations. Variable selectivity of the three i-f stages and one stage of r-f are incorporated in this set.

The Augetron is the principal exhibit of Vacuum Science Products, Ltd. This is a six-stage grid controlled electron multiplier having an indirectly heated cathode operating a $1\frac{1}{2}$ amp. at 2 volts. This tube requires about 300 volts per stage or 2,000 volts total anode voltage. Current in the final stage may be as much as 10 milliamperes and the overall transconductance is reported as being 40,000 micromhos. It is claimed that the voltage amplification of the order of 1,000 times can be secured from a single multiplier even in television application.

As has already been indicated, a feature of many of the radio receivers operating from the power line, is the use of a triode output tube. Pentodes are still being used on portable and smaller receivers for d-c operation. A number of firms displayed battery-operated tubes with filaments consuming 50 milliamperes at 1.4 volts. The Edison Swan Electric Co. showed the well-known high transconductance television r-f pentode, gas triode sawtooth oscillators, and other special television tubes. Short television tubes for magnetic deflection and focusing were displayed. The General Electric Co. introduced four new tubes having filaments operating at 2 volts. The main feature of the tubes (a triode-hexode, a duo-diode-triode, an output tetrode and a triode), is a reduction in filament current while improving or retaining the normal characteristics. High transconductance tubes with a

TELEVISION CAMERA INTERIOR

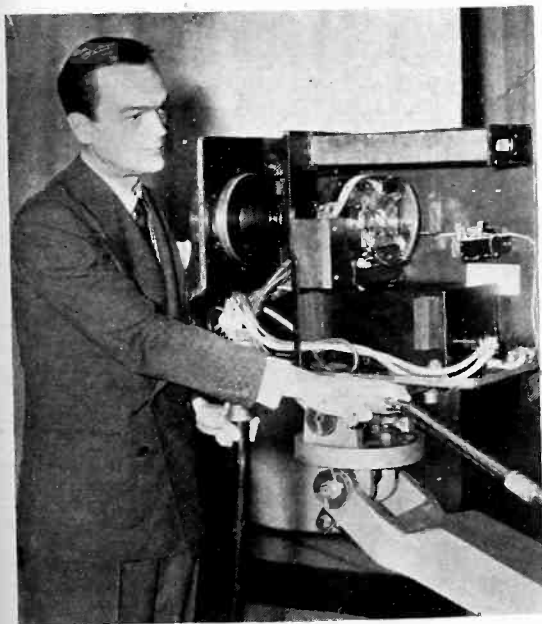

Inside view of the television camera which has been sending pictures from Hollywood where the Don Lee system operates as the only television transmitter on the West Coast. Thomas H. Lee, owner of Hollywood's only telecasting station, with the camera.

INSULATION HEADQUARTERS

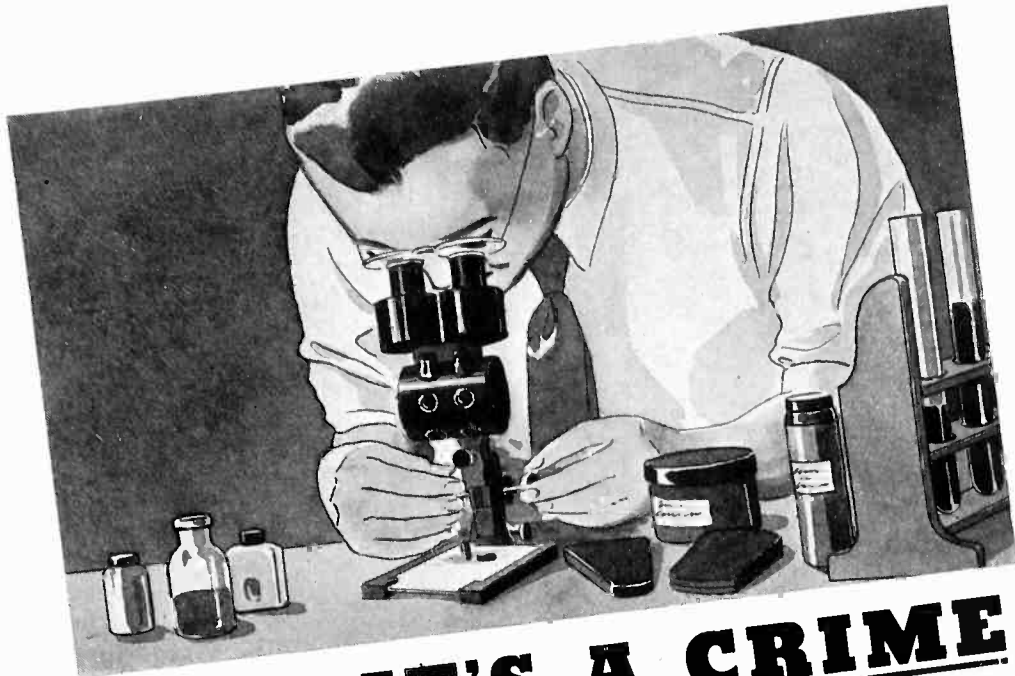

IT'S A CRIME

To use an insulation that is not exactly right for the job

There are actually countless formulae on record here at Continental-Diamond. Each for an insulation of *known* characteristics — each exactly right for some specific requirement. When our Engineering Service Department is asked to produce a material for some unusual service it can draw upon a fund of knowledge and experience unequalled in the insulation field. This technical help is yours for the asking and may be the means of improving your product's performance, reducing manufacturing costs or simplifying assemblies. Write us today.

CONTINENTAL-DIAMOND FIBRE CO.

Newark, Delaware

Represented in Canada by DIAMOND STATE FIBRE CO. OF AMERICA, LTD., TORONTO

DILECTO

A laminated plastic, commonly known as phenol fibre, made in sheets, rods and tubes or fabricated parts to specifications. Has high electrical insulation properties, great resistance to water, practically unaffected by oil or mild acids. It is a strong, tough material with a wide application for use in connection with modern electrical appliances.

DIAMOND VULCANIZED FIBRE

A tough, economical, insulating material made in standard sheets, rods and tubes. Can be readily fabricated or formed. A material of countless applications.

VULCOID

A thermo-plastic, non-hygroscopic insulating material made in standard sheets, rods and tubes. It is strong and tough, has good electrical insulating properties and is readily fabricated.

MICABOND

Thin splittings of mica bonded together with specially developed binders into standard plates, tubing or in formed rings, punched and sawed segments or other special parts. Micabond has high dielectric strength, is practically unaffected by acids, has high heat and moisture resistance, is readily punched, sawed or formed.

CELLULAK

A laminated form of insulating tubing, possessing extremely high dielectric properties, and marked resistance to flash-over.

CELORON

A phenolic molded fabric base material of exceptional mechanical strength yet extremely light in weight. Can be molded to any desired shape and contour to replace intricate metal and insulation assemblies. Write for CELORON Bulletin.

NEW!

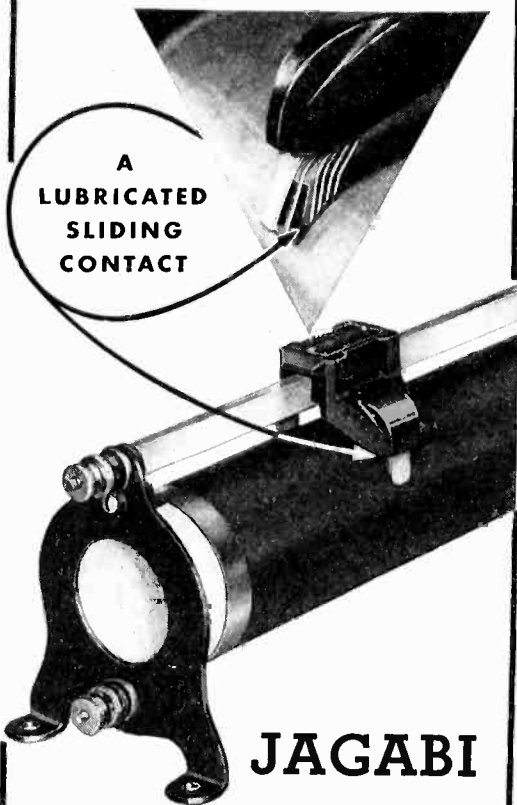

JAGABI
"Lubri-tact"

RHEOSTATS at new LOWER prices

In our constant efforts to improve Jagabi Rheostats, we have now introduced a *lubricated sliding contact*, which we believe to be the most important single improvement to our rheostats during the past 30 years.

This new feature, which we call "Lubri-tact"—from *lubricated contact*—eliminates scratching and abrasion and introduces a smoothness of fine adjustment that is remarkable. The electrical contact is actually improved and, because of the graphite lubrication, wear on brushes and winding is reduced to a minimum.

Bulletin 1620-E describes this new improvement and also lists new lower prices. Write for a copy.

JAMES G. BIDDLE CO.
 ELECTRICAL AND
 SCIENTIFIC INSTRUMENTS
 1211-13 ARCH ST. PHILADELPHIA, PA.

6.3 volt heater and an octal base were also displayed by G-E. An important application of electron devices was displayed by the Edison Swan Electric Co. who featured the Electroencephalograph which is a rather complicated low frequency amplifier and cathode ray tube for the examination of low frequency potentials established in the brain.

Linear DB Meter

THE CONSTRUCTION of a linear decibel meter having a range of more than 60 decibels is described by K. Akadawa and H. Uno in the May issue of *Electrotechnical Journal*, published by the Institute of Electrical Engineers of Japan. The authors show the characteristics of a cuprous oxide rectifier whose resistance varies logarithmically with terminal voltages of from 0 to about +0.5 volts. By utilizing the logarithmic compression characteristics, a linear decibel meter for about 35 db can be obtained. By connecting several cuprous-oxide devices, as shown in Fig. 1, in a series-parallel arrangement

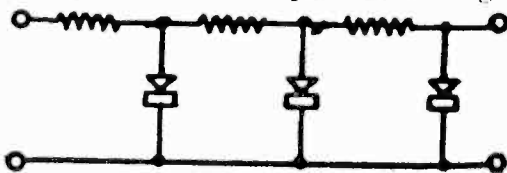

Fig. 1—Series-parallel arrangement for extending the logarithmic range of the rectifiers

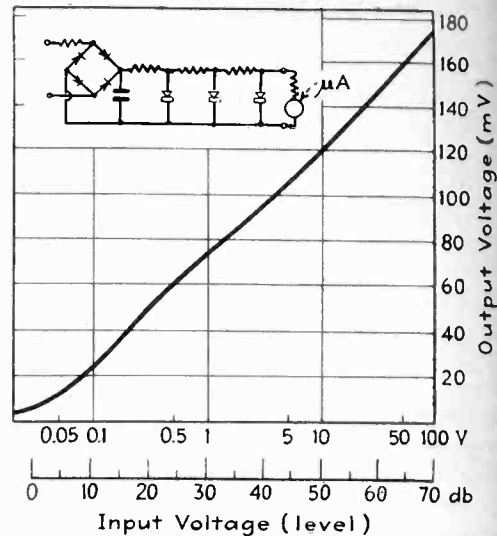

Fig. 2—Logarithmic characteristics of completed meter with meter connections shown in upper left

ment, the linear decibel scale may be considerably extended. In brief, the voltage relations of the resistances and copper oxide devices are such that when the linear decibel relation of one rectifier is exceeded, that of the next comes into play, and so on, so that the total range may be considerably extended over that of the single rectifier unit.

Based on this principle, the authors have succeeded in obtaining a decibel meter capable of measuring linearly more than 70 db by adding selenium or cuprous oxide rectifiers in series parallel as shown in Fig. 2.

WAXES • COMPOUNDS for ELECTRICAL INSULATION

Zophar offers prompt service on Insulating Compounds for a wide variety of electrical applications, including:

... Insulation for CONDENSERS, TRANSFORMERS, COILS, power packs, pot heads, sockets, wiring devices, wet and dry batteries, etc. Also WAX SATURATORS for braided wire and tape. WAXES for radio parts.

Special compounds made to your order.

ZOPHAR MILLS INC.

130-26th St.

Brooklyn, N. Y.

FOUNDED 1846

NEW SUPER HI-POWER GENEMOTOR for Heavy Duty Service

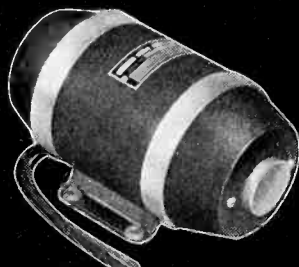

150 Watt, Weight 13½ lbs.
 8½" Long, 4½" Wide, 5" High

Sets a new high standard for Power Units used on Marine, Police, and Aircraft Radio. The exceptional Hi Efficiency, small size, and light weight are the result of a new type, one piece field ring, and armature design. Grease packed ball bearings require no oiling or attention. Double enamel and silk wire on armature insure trouble-free operation; end dust cover removable. Made in two sizes, 150 and 225 watt output, up to 1000 volts, input 5.5 volt and up.

There is a Carter Genemotor or Converter for every requirement. Write for further information

CARTER MOTOR CO.

1606 MILWAUKEE AVENUE

CHICAGO, ILLINOIS

Determination of Natural Physical Constants

IN THE DEPARTMENTAL Resumés of Recent Research in the September issue of the *Journal of Applied Physics*, an abstract and critical discussion of J. W. M. DuMond's article in the July 15 issue of the *Physical Review* is given.

In this abstract it is pointed out that of the three fundamental constants, e the electronic charge, m the electronic mass, and h Planck's quantum of action, e is the only one which can be measured directly with precision without involving the other two. The interrelation existing between the constants is indicated and the results of measurement by a number of workers are given in a convenient graphical representation which permits a clear insight into the tangle of determinations of the various constants. From the graph given (which includes a number of revisions and additions which do not appear in the July 15 issue of the *Physical Review*) variously orient claims represent the different experimental determinations of e , m and h .

After the analysis and rejection of several hypotheses as to the origin of the discrepancy between the various experimental measurements, the conclusion is drawn by DuMond that experiments leading to the determination of h/e should receive careful attention.

Those desiring further information on this subject are referred to the July 15 issue of the *Physical Review* and to the September issue of the *Journal of Applied Physics* for the revised graphical presentation.

AIRPLANE TELETYPE SERVICE



Ground transmitter which is used for sending teletype radio messages to airplanes. With this equipment, it is possible to communicate with planes either by voice or through the use of teletype equipment. P. D. McKeel, of the Civil Aeronautics Authority, is shown operating the transmitter.

At Last! A BEAM TETRODE with INSTANT- HEATING FILAMENT

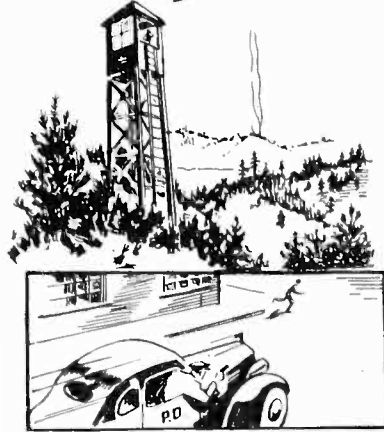

for communications service. Superior Performance—Reduced Battery Drain where transmitting period is but a fraction of the total time. The ideal tube for two-way transmitters.

Characteristics of Hytron HY69

Thoriated-tungsten filament.....6.3 volts @ 1.5 amp.
Plate input.....600 max. volts & 100 max. ma.
Screen input.....300 max. volts & 15 max. ma.
Plate dissipation.....40 max. watts
Nominal R.F. output at max. input.....42 watts
Shielded for R.F.....requires no neutralizing
Full ratings allowable for radiophone operation up to 60 megacycles.

HY69



\$3.50

Standard 5-prong ceramic base.

Other Hytronic Products

In addition to the above, there is a complete line of low and medium-power transmitting types also suitable for diathermy, U-H-F tubes, low-loss ceramic-based "Bantams," and low-drain "Bantam Jr." tubes for wearable hearing aids.

HYTRONIC LABORATORIES
A Division of the Hytron Corp., Salem, Mass.

NEW CIRCUIT CONTROL LEACH RELAYS

Dependable operation of control circuits is assured by this new line of 4 and 6 ampere relays. Built to Leach quality standards.

Pole pieces are nickel-plated, heat-treated Beryllium copper. Nothing is grounded to the frame.

All parts and pieces are so constructed that nothing can twist or turn out of alignment. All iron parts are heavily cadmium plated. Canvass-base bakelite is used throughout for insulating purposes, unless otherwise specified. Can be supplied for either AC or DC operation.

Write for our NEW catalog describing our complete line of dependable relays.

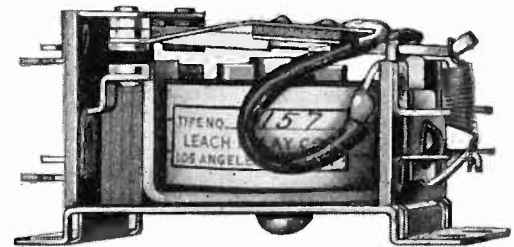

Type 1157

Contact: 1/4" diameter Pure Silver. Rating: 6 amperes at 115 volts AC. List Price: \$4.50

LEACH RELAY COMPANY

5915 Avalon Boulevard, Los Angeles, Calif.

15. E. 26th St., NEW YORK CITY

Lawrence and Lamson Aves., CHICAGO

MOLDED S.S. White RESISTORS The "All-Weather" Resistors.

AMONG THE USERS

Radio Corporation of America
RCA Manufacturing Co., Inc.
RCA Communications, Inc.
General Electric Co.
Westinghouse Elec. & Mfg. Co.
Automatic Electric Co., Ltd.
Bartol Research Foundation,
Franklin Institute
R. S. Hart — Moisture Gauge
Merck Institute of Therapeutic
Research
National Technical Laboratories
Roller-Smith Company
General Talking Pictures Corp.
National Broadcasting Co.
Pan American Airways, Inc.
Railway & Industrial Engineering Co.
U. S. Army and Navy
Griffith Observatory
Air-Track Manufacturing Corp.

... 1,000 OHMS TO
1,000,000 MEGOHMS

Full details and illustrations in
RESISTOR BULLETIN 37
Free copy with Price List sent
on request. Write for it.

NOISE TESTED

At slight additional cost, resistors will be supplied individually "noise-tested" to this specification: "For the complete audio frequency range, resistors shall have less noise than corresponds to 1 part in 1,000,000." (For values up to 10 megohms)

S. S. WHITE

The S. S. White Dental Mfg. Co.
INDUSTRIAL DIVISION

Department E, 10 East 40th St., New York, N. Y.

for **TELEVISION, too!**
... **CANNON** develops
CO-AXIAL CONNECTOR ...



CANNON Multiple Circuit Cable Connector of 34 Poles, with 4 Center Poles Shielded Concentrically thru Plug.

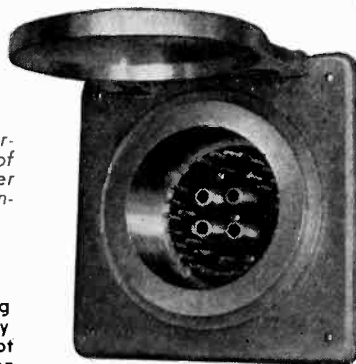

LIMAXING more than 25 years of manufacturing experience under the same management—many of which have been devoted to the development of Multiple Circuit Plugs and Receptacles—the Cannon Company has completed a Multiple Cable Connector with Co-axial contacts for television.

The use of this Multiple Connector with the Co-axial poles makes possible any combination of contacts with the shielded circuits for high frequency current. The completion of the Connector, with its Co-axial poles completely shielded through the plug, marks the first time that the application has been accomplished successfully in a Multiple Cable Connector. . . . Pictured here is the type developed for the Radio Corporation of America and the General Electric Company . . . With more than 1,000 stock fittings, the Cannon line now comprises the greatest variety of Multiple Cable Connectors offered by any manufacturer in the world. CANNON Plugs are pre-eminent for Sound Service and allied applications, in Aeronautics, Geophysical Research, Ship-Control and Laboratory Panels. They are described fully in a series of Illustrated Bulletins.

When requesting Bulletin, please specify your particular requirements.

CANNON ELECTRIC DEVELOPMENT CO.

★ 420 West Avenue 33, Los Angeles, California

★ EASTERN SALES OFFICE, 220 Fifth Ave., New York, N.Y.

CANNON PLUGS



Meters for Use Over Wide Frequency Range

IT IS COMMON practice to design a-c measuring instruments with a single scale when the voltages to be determined are below a certain limiting frequency. In an article "Frequency Compensation for A-C Measuring Instruments" by Carl-Heinz Sturm, appearing in the *Funktechnische Monatshefte* for June 1939. The author shows why it is necessary to use multiscale instruments for the higher frequencies. This article by Sturm is practical and comprehensive and includes a listing of formulae useful to the instrument designer.

In designing for a certain frequency range it is necessary of course to know the ohmic resistance of the measurement network and also its inductive reactance so as to compensate for them in the frequency range from f_1 to f_2 .

The ohmic resistance for current or voltage measurements is determinable with direct current. The inductive reactance is determined for both current and voltage ranges by the use of an a-c source of known frequency. According to Fig. 1 there will be a current I flowing with a voltage V indicated when the a-c source of frequency f is utilized on the circuit shown.

The current flowing through the voltage indicator of resistance R_v must be subtracted from the total current in order to determine that which flows through the network of R_m and L_m . Thus

$$I_n = I - (V/R_v)$$

Now with current, voltage, and frequency known there are two possible methods of determining the inductive reactance ωL of the network.

The impedance of the R_m , L_m arrangement, namely Z_m , is determinable

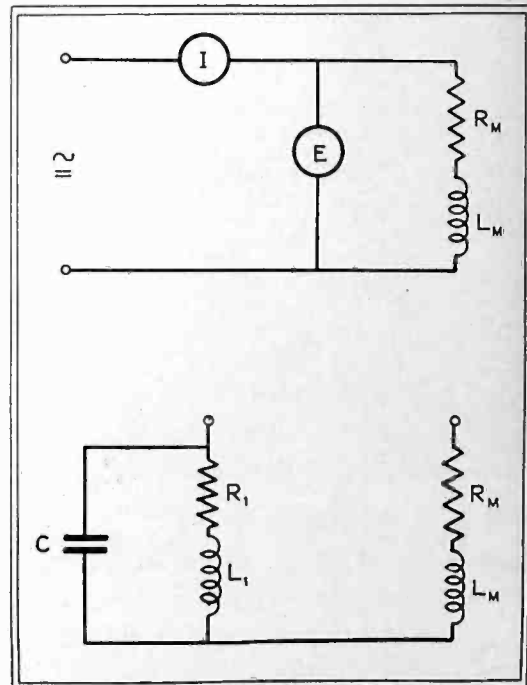

Fig. 1 (above)—Measurement of voltage and current into a meter whose resistance is R_m and whose inductance is L_m . Fig. 2 (below)—Equivalent circuit of Fig. 1 when frequency compensation is employed

If it's "SOCK"
you want . . .



Here's WATT you need

Atlas P. M. Driver Units and Exponential Trumpets are unquestionably the first choice of public address and communications engineers . . . where power and maximum sound coverage is required.

Years of experience in unit and trumpet building mark the latest Atlas models as the ultimate in modern sound reproduction. High ratio of acoustic transfer efficiency . . . no phase distortion . . . lifelike quality . . . All combine to insure the success of any P. A. installation. Why not have Atlas P. M. Driver Units and Trumpets work remarkable results for you?

Here's Helpful Literature . . .

Send for bulletins on Atlas P. M. Driver Units and Trumpets, "Marine" Horn and Unit, and your copy of Catalog F-39 describing a complete line of sound equipment.

ATLAS SOUND CORP.

1454 - 39th Street Brooklyn, N. Y.

BLILEY



CRYSTALS

The complete Bliley line includes ovens, holders and crystals for all frequencies from 20 kc. to 30 mc. Several new units have recently been developed for high frequency mobile work. Write today for Catalog G-11 for full description.

BLILEY ELECTRIC COMPANY
UNION STATION BUILDING PHILADELPHIA, PA.

from $Z_m = V/I$ and from the geometrical subtraction for vector quantities we can find L_m .

$$\text{Thus, } \omega^2 L_m^2 = Z_m^2 - R_m^2,$$

$$\text{then } L_m = \frac{\sqrt{Z_m^2 - R_m^2}}{\omega^2}$$

The equation, as previously stated, is a relation between the vector quantities so common in a-c theory and it naturally follows that the unknown L_m can also be determined from a vector triangle drawn to scale.

With frequency compensation the circuit arrangement can be shown to have the form of Fig. 2.

The complex impedance of condenser C is $Z_c = -j/\omega C$. Since C is coupled in parallel with the series arrangement of R_1 and L_1 , the complex impedance of the network is given by:

$$Z_k = \frac{Z_1 Z_c}{Z_1 + Z_c} = \frac{(R_1 + j\omega L_1) \left(\frac{-1}{j\omega C} \right)}{(R_1 + j\omega L_1) - \frac{1}{j\omega C}}$$

the total impedance is $Z_m + Z_k$.

With d-c measurements on the network arrangement in Fig. 2 it is seen that only R_1 and R_m , which here include the resistance of their respective inductances, enter, as the reactance of C is infinitely high.

The previous relation can then be shown to be $Z_{\omega=0} = R_m + R_1$.

For frequency compensation from f_1 to a higher frequency f_2 we equate the impedances:

$$Z_{\omega_1} = Z_{\omega_2} \text{ where } \omega_1 = 0 \text{ and } \omega_2 = 2\pi f_2.$$

$$\text{This gives } R_m + R_1 = R_m + j\omega_2 L_m +$$

$$-j \frac{R_1}{\omega_2 C} + \frac{L_1}{C}$$

$$R_1 + j\omega_2 L_1 - j \frac{1}{\omega_2 C}$$

Subtracting R_m from both sides and multiplying through by the denominator of the third term on the right we have:

$$R_1^2 + j\omega_2 L_1 R_1 - j \frac{R_1}{\omega_2 C} = j\omega_2 L_m R_1$$

$$- \omega_2^2 L_m + \frac{L_m}{C} - \frac{jR_1}{\omega_2 C} + \frac{L_1}{C}$$

$$\text{Equating reals we get: } R_1^2 = \omega_2^2 L_1 L_m$$

$$+ \frac{L_m}{C} + \frac{L_1}{C},$$

and for the imaginaries $\omega_2 L_1 R_1 = \omega_2 L_m R_1$, so that $L_1 = L_m$

Solving Eq. (1) for C we find that

$$C = \frac{2L_m}{R_1^2 + \omega_2^2 L_m^2}$$

The form of this equation indicates that the capacity C is a function of ω_2^2 and therefore, theoretically, there can be no complete compensation throughout the entire frequency range from f_1 to f_2 . The variation for real values between f_1 and f_2 is very slight so long as $\omega_2^2 L_m^2$ is small in comparison to R_1^2 . Even with a relation of $5\omega_2^2 L_m^2 = R_1^2$ the largest error is less than 3 per cent.

ROLLER-SMITH 4" INSTRUMENTS

are just the right size for small switchboards, panels, "built-in" equipments and many other applications. They are available in surface and flush cases and may now be had in the new square cases, as illustrated.

The line includes both direct and alternating current ammeters, microammeters, milliammeters, voltmeters, millivoltmeters, single and polyphase wattmeters, frequency meters and pyrometers.

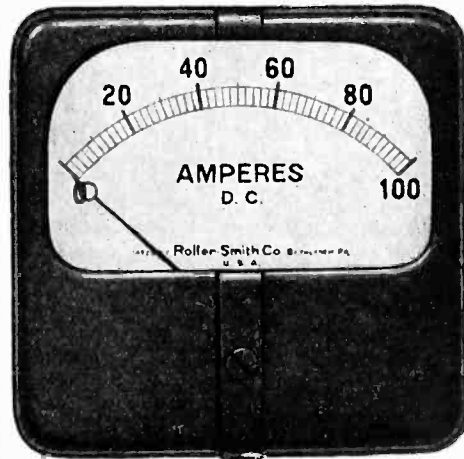

Long scales, exceptionally high accuracy and illuminated dials (if ordered) are some of the outstanding features of these instruments. Complete listings and technical details are given in Catalog AK-48-a, which will gladly be sent on request.

A companion line of 3" instruments is shown in this same Catalog. The 3" instruments are a little smaller than the 4" ones but have the same high qualities.

ROLLER-SMITH COMPANY

MAIN OFFICE AND WORKS:
BETHLEHEM, PA., U. S. A.

Sales Agencies in Principal Cities
in United States and Canada

"PINCOR"



Silver Band
DYNAMOTORS

**SMOOTH
QUIET
DEPENDABLE**

"PINCOR" offers the only complete line of "B" power supply equipment for police units, aircraft and radio broadcast service and sound systems. Available in a wide range of frames, sizes and capacities to fit any particular requirement.

"PINCOR" dynamotors are the last word in efficiency and regulation. Deliver high voltage current for proper operation of your apparatus with a minimum of A. C. ripple. These units will give years of smooth, quiet, satisfactory service. They are compact, light weight. Available with or without filter. Send coupon for catalog.



PIONEER GEN-E-MOTOR CORP.

Dept. R-4J

466 W. Superior St., Chicago, Illinois

Export Address
25 WARREN ST.
NEW YORK, N. Y.
U. S. A.

Send for **FREE**
Copy Today!



PIONEER GEN-E-MOTOR CORPORATION
Dept. R-4J, 466 West Superior St., Chicago, Illinois
Without obligation kindly send me "PINCOR"
Silver Band Dynamotor catalog and data sheets.

Name
Address
City State

The Augetron

A DESCRIPTION of what is perhaps the first commercially available multistage electron multiplier is contained in the September issue of *Television and Shortwave World* for September 1939. The tube is manufactured by the Cossor and is available in England.

Essentially, the structure of the "Augetron" is similar to the electron multiplier devices described several times in *Electronics*. The tube, which has terminal connections at each end, contains six stages, and is operated at an overall anode voltage of 2,000 volts, or approximately 300 volts per stage. When operated under these conditions, each normal secondary emitter gives a stage gain of approximately 2½. The final stage consists of a flat plate secondary emitter preceded by a flat perforated plate selector. This arrangement is found to give a gain equivalent to a multiplication of approximately 7. The overall gain is 1,000 for the entire six stages. The cathode is in the form of a suitably sensitized metal plate, in which has been punched a large number of holes in funnel shape depressions. The collecting fields due to the succeeding positive electrodes can penetrate through the holes at the bottom of each depression and so the secondary electrons go through and are accelerated in the desired direction to the succeeding anode.

The output current is limited to

approximately 10 milliamperes, and since the gain is about 1,000, the input current must be limited to 10 microamperes.

• • •

Measurements of A-C Arcs

THE SEPTEMBER ISSUE of the *Journal of Applied Physics* contains an article by S. G. Eskin entitled "Energy Measurements of Reigniting A-C Arcs."

According to the author's summary, an oscillographic study of arcs formed between silver contacts in the rupturing of 120 volts a-c circuits containing resistive loads shows that reignition of the arc occurs at low speeds of contact separation. Data has been obtained by means of a ballistic wattmeter showing the effects of current and line voltage on arc energy for silver contacts opening at speeds from 0.024 to 16.7 in. per second. In the low speed range reignition is more prevalent at 225 volts than at 115 volts, and restriking of the arc occurs at higher speeds for higher current. The formation of an arc in reigniting cycles is believed to be due to field emission of electrons, and average fields of 3×10^5 volts per centimeter being found for all cases of reignition observed. Reignition occurred at potentials as low as 72 volts and the intermediate glow discharge normally observed in the interruption of inductive circuits did not appear.

**STABILIZED A. C. VOLTAGE
UP TO 25 KVA**

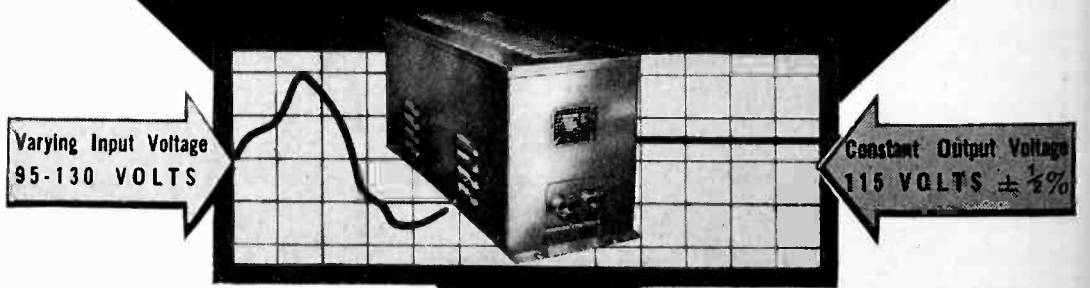

INSTANTANEOUS ACTION

NO MOVING PARTS

When a precision electrical device or a critical process is powered from an AC line, a Raytheon Voltage Stabilizer will permanently eliminate all of the detrimental effects caused by AC line voltage fluctuations. Made for all commercial voltages and frequencies, single or three phase.

Raytheon's twelve years of experience in successfully applying the Stabilizer to hundreds of perplexing voltage fluctuation problems is at your service. It will pay you to take advantage of our engineering skill.

Write for Bulletin DL48-71 JE describing Raytheon Stabilizers.

RAYTHEON MANUFACTURING CO.
100 Willow Street, WALTHAM, Massachusetts

Portable Transmitter

(Continued from page 21)

which should be discussed in conclusion:

First, why the four binding posts and provision for separate filament battery? It must be realized that we are working with 6 volts where 6.3 is normal for the tube filaments. The loading effect of the dynamotor plus any drop which might be present in the filament wiring may bring this value below 6 volts. Thus the heavy filament wiring in the power cable. If the voltage drops below 5.5 a serious decrease in transmitter output occurs, accompanied by audio distortion. Therefore even with a new heavy duty storage battery it is reasonable to expect a maximum program length of 45 minutes. However oftentimes this type of transmitter may be called upon for golf course work etc. where periods of operation up to 2 hours are desired.

In this case two storage batteries are used. One runs the dynamotor and the other the filaments. This is accomplished by merely removing a shorting strap across the two positive posts as in the diagram. It will be seen also that it is possible to parallel both batteries easily if desired or series them for 8-volt input.

Under actual tests from boats and cars this system has given 2-3 hours continuous operation without any appreciable dropping of output. As long as the filaments are receiving a full 6 volts the plate voltages will remain proportional and linearity will be preserved even if the dynamotor battery drops off somewhat.

Set-ups can be accomplished in almost any type of conveyance in an average of 15 minutes. Most of the time is consumed in clamping the antenna and obtaining a ground.

The antenna in all cases so far has been a 12-foot vertical with a clamp type base which can either be screwed to a wood foundation or clamped to a bumper. It is also adjustable as to vertical angle. Grounds have been made to the chassis of a car or plane or to the motor in a boat.

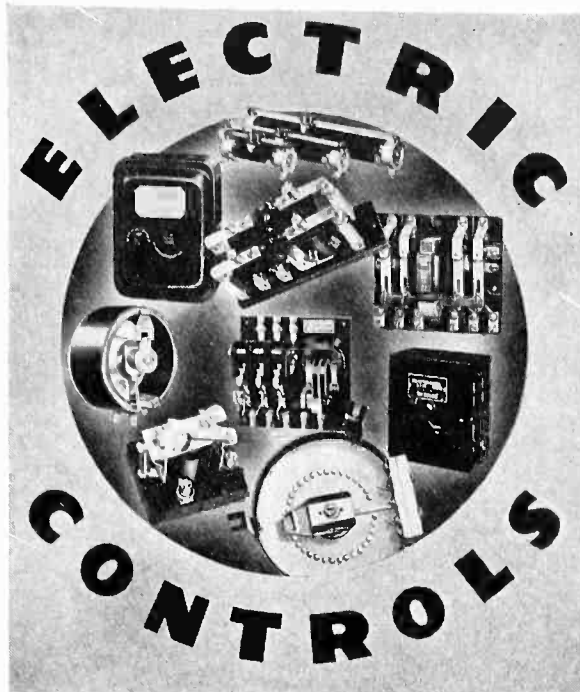

• • SEND FOR BULLETINS. Each bulletin gives dimensions, ratings, uses and construction features of a specific product.

RELAYS
RESISTORS
SPEED REGULATORS
CONTACTORS
VOLTAGE REGULATORS
MOTOR STARTERS



Ask for bulletins describing products of interest to you.

WARD LEONARD

ELECTRIC COMPANY

32 SOUTH STREET

MOUNT VERNON, N. Y.

Electric Controls Since 1892

Glass Fractionating* Diffusion Pumps

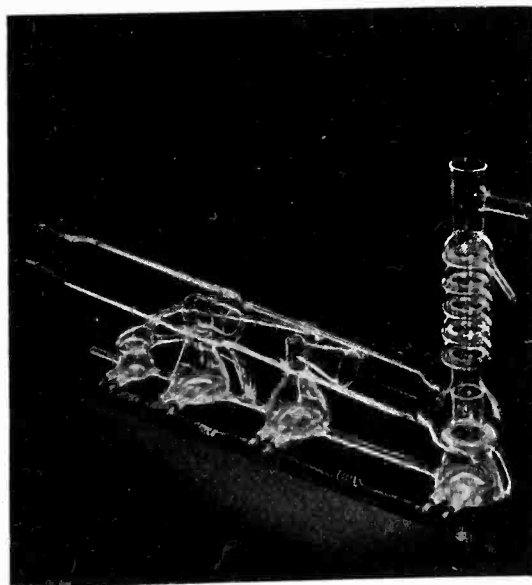

Glass Fractionating* Pump (Three-stage),
Type GF-15

LOWEST pressures (less than 5×10^{-8} mm. at 25° C.) are made possible by continuous purification of the pumping fluid during operation. Neither liquid air nor cold-trap is required for effective performance.

IMPORTANT TO:

Industry—for the economical exhaustion of glass vacuum systems.

Laboratories—for the exacting requirements of research.

Inquiries are invited regarding our aids to high-vacuum technology.

*U. S. Patents 2,080,421; 2,150,676; 2,153,189; and patents applied for.

DISTILLATION PRODUCTS, INC.

ROCHESTER, N. Y.



THE INDUSTRY IN REVIEW

The Audograph, a Recording Machine of New Design

A SOUND recording machine of radically new design has recently been announced by The Gray Manufacturing Co., Hartford, Conn., manufacturers for many years of coin telephone equipment. This machine is called the Audograph and incorporates many new features which make it capable of producing inexpensive high quality recordings. It is about the size of a standard typewriter, weighs about twenty pounds and is therefore readily portable. The acetate discs used on this machine are 0.005 inches in thickness and may be mailed or filed like letters.

The Audograph is a disc machine, but here a comparison with ordinary recording equipment ceases because a stationary, curved deck similar in appearance to a half cylinder has replaced the usual platen or turntable, the recording and reproducing styli are rigidly mounted and fully enclosed and in operation the record passes under the stylus rather than the stylus over the record.

The present model represents one of a group which, it is contemplated, will be developed to meet the requirements

of a number of applications. It was designed to be a practical dictating unit suitable for use in the average office under average acoustic conditions. In it, however, are incorporated the basic principles that go to make this system an economical and efficient method for producing recordings of a quality comparable to those in commercial use.

In general the driving mechanism of the Audograph may be divided into two parts. The first provides the constant linear surface speed at which the record is driven and the second produces the spiralling of the sound groove. There is no connection between these two sections except in operation when the record becomes in effect an essential link in the mechanism for it is through the record that the power applied to the drive mechanism is transmitted to the serrated record spindle and the feed screw to which it is attached.

The power section consists of a small, synchronous motor resiliently mounted on the chassis and connected through the reduction mechanism to a pair of drive rollers located adjacent

to the stylus. These drive rollers engage the record and cause it to pass beneath the recording stylus at a constant surface speed. The feed screw mechanism is located directly under the serrated record spindle and is geared to the spindle. As the record is rotated by the driving rollers the feed screw is turned at a constantly decreasing rate in direct relation to the increasing diameter of the sound groove.

Aside from the extreme simplicity of construction there are several advantages to this method of drive. Perhaps for this particular application the more important features are the ability instantly to start and stop with an action fast enough to split syllables, and the ability to maintain a constant surface speed. The advantage of constant surface speed is that it greatly increases the capacity of the record in recording time and that it maintains uniform groove formation throughout the record.

In the outward appearance of the Audograph the most noticeable departure from ordinary recording equipment is the absence of a turn-table. The paper-thin record revolves over a specially formed curved, stationary platform.

Another novel feature of this recording system is the revolving anvil which provides the base on which the sound groove is inscribed in the record. This anvil together with the stationary curved platform, drive mechanism and other novel control features, provides a means of recording for general commercial application which for quality of results, simplicity of operation, economy and compactness, surpasses any method of recording now available.

The Audograph was designed to overcome another objectionable feature of conventional recording, namely the elimination of the shavings or chips normally obtained during the cutting of wax or lacquer coated records and the frequent fouling or breakage of styli during the recording. In place of sapphires and steel needles and cutting, the sound groove is embossed in the record by means of a diamond stylus which does not require sharpening and lasts indefinitely. These styli are employed in the recording and reproducing heads of the Audograph and are specially ground and polished for the purpose. During the recording the effective pressure at the stylus point is several thousand pounds per square inch with the result that the sound groove is permanently impressed in the record.

The most desirable element for actuating the diamond styli was found

UNCLE SAM RECORDS BROADCAST PROGRAMS

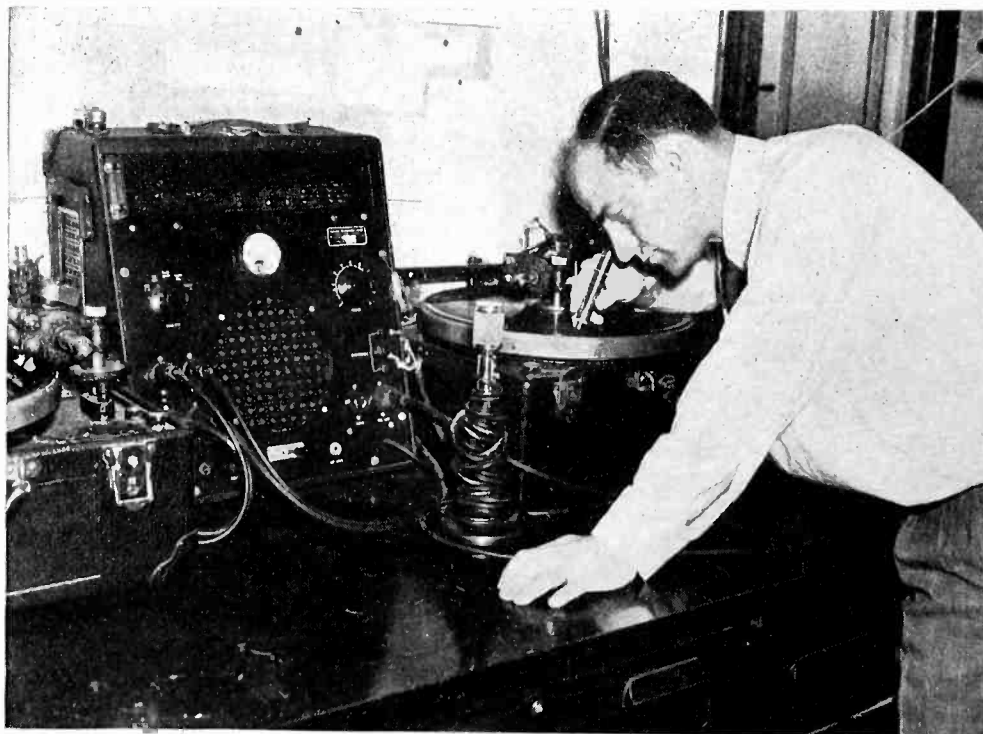

James Homsy, inspector in charge of the Sam Pedro monitoring station of the FCC, operates the recorder which makes records of programs which may not be construed as being in the public interest. The FCC monitoring stations throughout the country also keep track of the frequency at which radio stations operate and otherwise police the air.

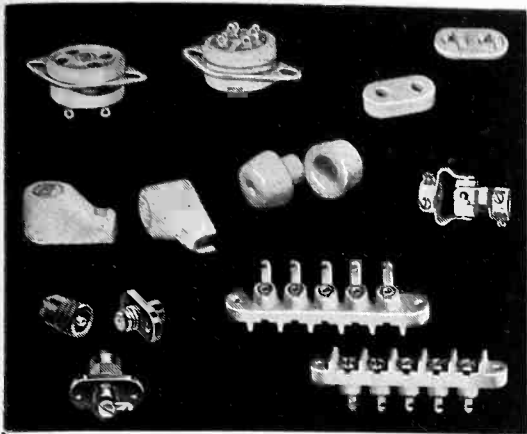

**For the Electronics Equipment
Manufacturer**

★ **NEW** ★

Safety Terminals, Insulated Rectifier and Thyatron Connectors, High Voltage Tube Sockets, Iron Core RF Chokers, Quartz Polystyrene Insulation, High Frequency Variable Condensers, Meter Type Dials, Cast Aluminum Chassis, etc.

Catalogue Upon Request

JAMES MILLEN
150 EXCHANGE ST.



MFG. CO. INC.
MALDEN, MASS.

**POWER
TRANSFORMERS**

**AIR-COOLED
TRANSFORMERS**

for Voltage reduction. Insulated and Auto Types,
from 1/4 K.-V. A. to 25 K.-V. A.

**SIGNALLING
TRANSFORMERS**

for reduction of line voltage to 4, 8, 12, 16,
20 or 24 volts 50 to 750 V. A.

**MERCURY VAPOR LAMP
TRANSFORMERS**

for maintaining the exact voltage necessary for
highest Mercury Vapor Lamp efficiency.

ACME also manufactures
Radio transformers in production quantities.
Luminous Tube transformers. Acme Voltrol for
0 to 135 volt voltage regulation. Acme Break-
down Tester. Your inquiries solicited.

THE ACME ELECTRIC & MFG. CO.
31 Water Street Cuba, N. Y.

Acme Electric
TRANSFORMERS

to be the piezo crystal. This element had the mechanical strength to withstand the pressure required to indent the hard acetate surface and at the same time had the frequency range for quality recording. The recording head on the Audograph is of this type and is very similar in design and characteristics to some of the crystal heads in use on professional recording equipment. It is rigidly mounted as to horizontal movement and may be moved vertically only to the extent necessary to perform the record and play-back operations.

The reproducing head likewise employs a crystal as its generating unit and has somewhat the same characteristics as the recording head. In this instance, however, the head has been designed particularly to meet the requirements of the office machine field. This head also is limited in its vertical movement by the control mechanism. Movement in the horizontal plane is held to plus or minus one-half groove off center.

In designing the amplifier employed in the present model of the Audograph, consideration was given to the requirements of the office machine field. The matter of background noises, intensity and volume all had to be taken into account in the design of the amplifier.

The amplifier in the present model has a frequency response of from 150 to 5000 cycles and has specially designed circuits which obviate, insofar as possible, the undesirable background noises but still permit the recording of a shout or a whisper without change in gain control and without danger to the recording element. What was formerly a manual operation has thus been made automatic.

Dictation equipment requires, perhaps, more control features than any

**RADIO SAFE LANDING
SYSTEM**



Although one might, at first, mistake this for some form of mechanized warfare unit, this motorcycle is a portable marker beacon used at Washington D. C. for the Air Track radio safe landing system. From the fog shrouded ground, the unit sends up a vertical fan of radio signals across the path of the incoming plane, which gives the pilot a definite signal which may be used in landing

We Wrote:

**"It can't
be done"**

Based on an
actual incident
from our files



REPORT

...your description and conditions of location for proposed antenna are unsuited for efficient operation of ANY tower. Suggest further investigation for new location.

**-and Lingo sold
another Radiator!**

This typical, unbiased Lingo report was sent by request to a Southern station contemplating a new antenna system. Further investigation by the station confirmed our report that the proposed location was not suitable. Acting on our advice, a new location was selected . . . and a Lingo Vertical Tubular Steel Radiator was purchased for greatest efficiency and economy.

Lingo technical experience—plus exclusive Lingo features of design—plus the experience of satisfied engineers throughout the country—are behind you when you choose a LINGO "TUBE" RADIATOR for your own important use. We're ready to serve you in the shortest time. The "time factor" of a recent job where we furnished complete engineering data in 3 hours, bears this out!

Write for details today!

Illustrated, technical folder sent on request. For pertinent data also give location, power and frequency of station. Write today.

JOHN E. LINGO & SON, Inc.

Dept. E-10

CAMDEN, N. J.

**LINGO
VERTICAL
TUBULAR STEEL
RADIATORS**

Engineer O.K.'d

**FOR ACCURACY
FOR PERFORMANCE
FOR PRICE . . .**

RCP TEST INSTRUMENTS

No question, RCP's got it! No other test instruments offer so many advanced features at such a surprisingly moderate price. And exclusive RCP features are directly responsible for the superior performance, for the accuracy, versatility and long-life dependability of this amazing, low-cost test equipment. Send for the full story of the testers O.K.'d by engineers on all three counts: accuracy, performance, and price.

RCP POCKET MULTI-TESTER—MODEL 413

IT TOOK RCP to design a pocket size instrument with all the sensitivity, ranges and features of the large expensive testers. Here is the same quality and accuracy of component parts, but think of the space and the money you save! Sensitivity: 400 microamps, or 2500 ohms per volt. Fine Alnico magnet identical to that used in ultra-sensitive, high cost meters. AC volts, 0/10/50/250/1000/5000; DC volts, 0/10/50/250/1000/5000. Ohms, 0/500/100,000/1,000,000. DC Microamps, 0/400; DC Milliamps, 0/10/100/1000; DC Amps, 0/10. In attractive natural finish wood case. **\$12.90 Net**



Pocket Size Multitester Model 412—identical except for the 5 DC voltage ranges. **\$9.95**



RCP ELECTRONIC MULTITESTER MODEL 660

ONLY IN AN INSTRUMENT COSTING 2 to 4 times the price will you find the same extraordinary ranges, the sensitivity and facilities for measuring large values this new DC vacuum tube voltmeter offers. Ranges up to 6000 volts DC and 1 billion ohms. Lowest voltage reading 0.1 volt. Gets its unusual sensitivity from an input resistance of 200,000,000 ohms on all ranges except 6 volts. Total of 12 ranges all on direct reading master scales. Extreme operating simplicity as well as remarkable versatility makes this instrument ideal for production line as well as service application. Supplied complete in hand-rubbed sloping walnut case. Net **\$18.85**

RCP MULTITESTER MODEL 409A

ACCURATE WITHIN 2%. Sensitivity 2000 ohms per volt. Exclusive system of AC measurements insures accuracy at all frequencies, all temperatures and all wave forms, within practical limits. Ultra sensitive ohmmeter has low range scale reading only 2 ohms at center. High range ohmmeter gives widespread readings at 10 megohms with completely self contained power supply. Can be used on both DC and AC lines or at any frequency. **\$12.95 AC. Net**



CATALOG with the complete story of the RCP Quality line of test equipment free on request.

RADIO CITY
PRODUCTS CO. INC.
88 PARK PLACE, N. Y. C.

other type of recording apparatus with the possible exception of some very specialized applications. All of these control functions are available on the Audograph but may be either manual or electrical, as desired. Furthermore, being electrical these functions may be controlled remotely from any point however distant. Such flexibility makes possible a truly centralized stenographic department.

The start and stop operations are accomplished by means of a simple cam and lever arrangement which raises or lowers the drive roller. Since there is no momentum and very little inertia to overcome, it is possible, as stated earlier, instantly to start and stop the rotation of the record.

The back spacing mechanism is operated through the same cable as the start and stop, and consists of a cam and pawl. During this operation the driving mechanism is released momentarily and the record is moved laterally without revolving.

The correction marker is located in the same housing with the recording and reproducing heads and in operation places a readily visible, colored mark on the record at the point of correction. This colored mark becomes embedded in the grooves and forms a permanent part of the record although it in no way changes the quality of reproduction.

**A CONTINUOUS
WORLD'S PAIR:**

A 280 Tube
and
"Sylvaloy"
Filament



VISIT OUR EXHIBIT IN THE
METALS BUILDING AT
THE WORLD'S FAIR.

WILBUR B. DRIVER CO.
NEWARK, NEW JERSEY

News

◆ Pioneer broadcasting station KDKA is being moved from its present location at Saxonburg to Allison Park, Pa. and will give improved coverage of metropolitan Pittsburgh. A feature of the new transmitter will be the automatic replacement of inoperative tubes by pushing a button. The defective tube is removed from the circuit and a reserve tube placed in service immediately with little loss of station time and small hazard to operators . . . Victor O. Allen is now Technical Director of Wilbur B. Driver Co., Newark, N. J. He was formerly with RCA and Hygrade Sylvania . . . That television reception is feasible aboard small yachts and other craft was recently demonstrated on a 35-foot sail boat in Long Island Sound by Dr. Thomas Goldsmith of Allen B. Dumont Labs . . . General Electric has developed a nine-inch cathode ray oscilloscope good to higher than 5 Mc. G. E. has also developed a new line of pointer-stop instruments for measuring currents or voltages of short duration . . . Kendall Clough, president and chief engineer of The Clough-Brengle Co. is now directing instrument sales of that company . . . High definition television demonstration systems are now located in Pittsburgh, St. Paul, and Salt Lake City as well as in the New York World's Fair and the Golden

**PROFESSIONAL
SERVICES**

(Rates on Application)

**ELECTRICAL TESTING
LABORATORIES**

Characteristics of Vacuum Tubes
Tests of photo cells, glow lamps, crater lamps.
Tests of electronic and optical devices
East End Avenue and 79th Street
New York, N. Y.
Phone: Butterfield 8-2600

INTERNATIONAL ELECTRONICS, INC.

DESIGN AND DEVELOPMENT

Radio Television
Sound Electronics

MANUFACTURING METHODS

Condensers Tubes Resistors
Vibrators Lamps Speakers
630 Fifth Avenue New York, N. Y.
Cable: Interengin, New York

HAROLD J. McCREARY

Mem. A.I.E.E. & W.S.E.
Consulting Engineer

Laboratory Facilities

Research Electronics
Development Television
Design Radio
Factory Practise Railroad Signaling
Patent Studies Telephony

105 W. Adams St. Phone STate 4003 Chicago, Ill.

PHOTOBELL CORPORATION

Consultation—Designs—Models

Photo-electric applications for industry

COUNTING: cans, cartons, people

CONTROLS: machinery, weighing, signs

ALARMS: burglar, smoke, etc.

125 Liberty Street, New York City

Gate Exposition . . . B. A. Proctor Co., Inc., designers of sound recording equipment, have removed their offices from 17 West 60th St. to 230 Park Ave., New York. The laboratories will remain at the 60th St. address. The Proctor Company has recently granted the Gray Manufacturing Co., Hartford, Conn. a license under issued and pending patents to manufacture and market a disc recording machine of radically new design known as the Audograph . . .

RCA and Farnsworth have entered into agreements whereby each may use the inventions of the other in the fields of television and in other fields of their respective businesses . . .

Gano Dunn, president of J. G. White Engineering Corp. and of Cooper Union, has been chosen as the 1939 recipient of the Hoover Medal, "awarded by engineers to a fellow engineer for distinguished public service" . . . Arthur Isbel has resigned as Manager of the Commercial Department of RCA Communications. He is succeeded by George Shecklen who had been in charge of RCA Communications in China.

Literature

Parts. Sockets, plugs, connectors, switches, insulators, transmission lines, etc., are described in Catalog 57-J by American Phenolic Corp., 1250 Van Buren St., Chicago.

Steelstrap. Stopping profit leaks beyond the production line by efficient packaging. A booklet by the Acme Steel Co., 2840 Archer Ave., Chicago.

Microphone. Model TR-56 Bullet sensitive microphone described in booklet by Transducer Corp., 42 West 48th St., New York.

Receivers. Communication receivers, pre-selectors, band expanders, i-f transformers and other accessories are described in Catalog No. 89 by Radio Manufacturers Engineers, Inc., 111 Harrison St., Peoria, Ill.

Parts. Condensers, dials, drives, scales, knobs, coils, forms, couplings, chokes, insulators, foundation units, i-f transformers, Hetrofil, and other accessories described in booklet by James Millen Mfg. Co., Inc., 6 Pleasant St., Malden, Mass.

Welding Equipment. Automatic Thyatron-controlled arc-welding equipment is described in Publication GEA-3042A. Ignitron Contactors for spot and projection welding are described in Publication GEA-3058A. Formex magnet wire is described in Publication GEA-2973. All by General Electric Co., Schenectady, N. Y.

Test Equipment. More than 40 models are described in the 1940 catalog of Precision Apparatus Co., 647 Kent Ave., Brooklyn, N. Y.

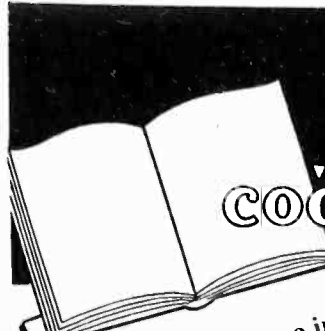

Coördinated CONTROL

** Coördinate—To place in harmonious or reciprocal relation. That which is of the same order, rank, power, etc.*

Better performance of any machine depends largely on the relationship of one control element to another. From the simplest relay to intricate combinations — your control problem can best be solved using the experience, research and practise of a trained staff specializing in the design and production of coördinated controls.

COMPLETE CONTROL ASSEMBLIES

designed and built by experienced hands — will cut experimental costs to a minimum — speed deliveries!

Cut experimental costs to a minimum by submitting your control problems to Guardian Electric. Whatever you need — from the simplest small relay to complete control assemblies — can be compactly designed, completely fabricated and tested at Guardian — delivered ready for mounting in your machine.

Any Quantity AS You Want Them — WHEN You Want Them!

Let Guardian engineers work with you . . . for you. Ask us to make specific recommendations. Write for Catalog "E" Today!

GUARDIAN ELECTRIC

1625 W. Walnut Street

Chicago, Illinois

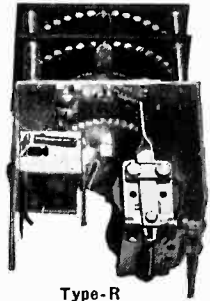

Type-R Stepping Relay

REMLER Silver-Tap Attenuators

Self-cleaning silver blades on silver taps (.030" solid silver) machined to precision "floated" in ball bearings assuring unequalled smoothness of operation. Clock Spring pig-tail. The single sliding contact in the input circuit results in contact noise being attenuated within the unit in direct proportion to the loss introduced in the circuit providing constant noise to signal ratio. Impedance practically constant over the entire range of the pad. Long life; trouble-free service. Famous Remler quality.

Standard impedances of 50, 200, 250 and 500 ohms. Special values to order

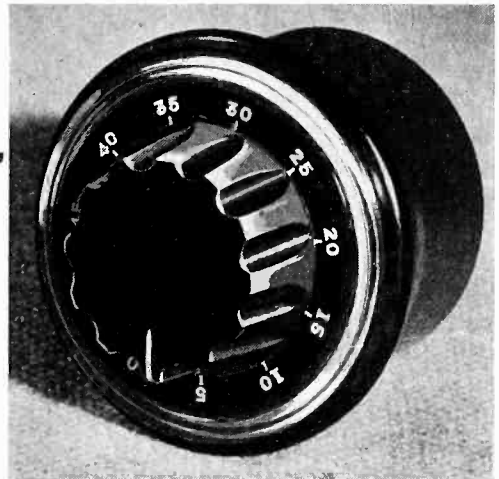

REMLER COMPANY, Ltd., 19th at Bryant, San Francisco

Non Resonant

Only University Loudspeakers have all the following specifications:

- Absolutely non-resonant under all conditions
- Highest acoustic output to overcome worst background noise
- Lowest harmonic distortion at low and high acoustic levels
- Maximum possible electro-acoustic conversion efficiency
- Totally waterproof under all climatic conditions
- Uniform frequency response over wide projection angle

Write for descriptive and technical catalog E-39

UNIVERSITY LABORATORIES

195 Chrystie Street New York City

University Laboratories LOUD SPEAKERS FOR EVERY TYPE OF SOUND SYSTEM



Announcing in Fluorescent Materials FOR TELEVISION TUBES

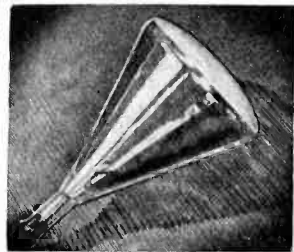

Callite Products, pioneer in FLUORESCENT MATERIALS, now has available for immediate delivery SILICATES and TUNGSTATES, in all colors in the spectrum, for Cathode Ray Television Tube applications. Callite engineers will be glad to cooperate with you in finding the proper fluorescent material for your tube design.

CALLITE LEAD-IN WIRES OF TUNGSTEN—MOLYBDENUM—KULGRID

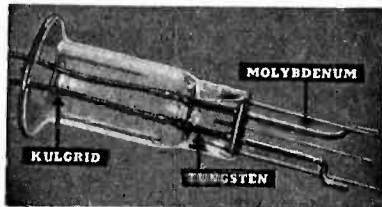

Tungsten in Callite Hard Glass Welds is processed to give compact fibrous structure free from longitudinal cracks and is centerless ground to eliminate surface imperfections.

Molybdenum supports are rigid and maintain proper alignment of tube parts. Only pure metals of best quality are used.

Accept no inferior substitutes. For more detailed information write to engineering department. Your inquiries are invited.

Kulgrid 'C' Strand does not oxidize, does not become brittle, and welds more readily to tungsten and copper.

CALLITE PRODUCTS DIVISION

EISLER ELECTRIC CORP. • 544 39th ST. • UNION CITY, N. J.



Note These Features of This New Webster Electric Crystal Pick-up!

Moisture-proofed crystal element . . . Frequency response range from 50 to 8500 cycles . . . Rubber cushioned arm assembly . . . Needle pressure of only 2.5 ounces . . . Convenient single hole mounting for motor boards from 1/16" to 1/2" thick . . . Write for technical details.

WEBSTER ELECTRIC COMPANY
RACINE, WISCONSIN, U. S. A. Est. 1909
Export Dept.: 100 Varick Street, New York City. Cable Address: "ARLAB" New York

*Licensed under patents of the
Brush Development Company*

Webster Electric

"Where Quality is a Responsibility and Fair Dealing an Obligation"

Sensitive! Powerful!

KURMAN RELAYS

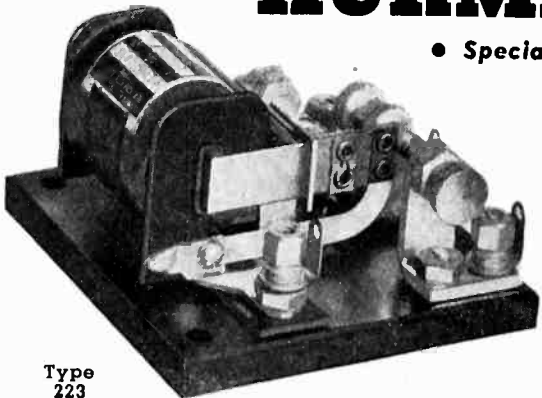

Type 223

• Specially Adapted for Aircraft Radio

Type 223 is particularly adapted for speed keying of high voltage, high frequency current.

Meets conditions encountered in aircraft radio demand.

Kurman Relays are unaffected by position or vibration

Provided with Mica-insulated balanced armature-contact arm assembly. Full particulars in Bulletin 210.

Send for it . . . TODAY!

KURMAN ELECTRIC CO. . INC.
241 Lafayette St., New York City

Trouble Shooter's Manual. Volume X of Rider's Manual contains descriptions of 2600 models of radio receivers. Also information on television, facsimile and electronic musical instruments. John F. Rider, Publisher, 404 Fourth Ave., New York.

Parts. A large variety of parts including switches, volume controls, condensers, resistors, pilot lights and many other parts are described in the 1940 catalog of P. R. Mallory & Co., Inc., Indianapolis, Ind.

Solenoids, coils and transformers are featured in a catalog by Dean W. Davis & Co., Inc., 549 Fulton St., Chicago.

Parts. A wide variety of parts, i-f transformers, condensers, hardware, etc., are described in Catalog No. 40 by J. W. Miller Co., 5917 South Main St., Los Angeles.

Resistors. Wire wound resistors of close tolerance are described in a catalog by Instrument Resistors, Inc., 375 Main St., Little Falls, N. J.

Resistors. Resistors and rheostats are described in Circular 507 by Ward Leonard Electric Co., Mount Vernon, N. Y.

Standards. A historical paper on the development of standards in this country is given on page 227 of Industrial Standardization. American Standards Association, 29 West 39th St., New York.

Service Equipment. Latest instruments are described in Catalog No. 12 by The Hickok Electrical Instrument Co., 10514 Dupont Ave., Cleveland, Ohio.

Loudspeakers. Both electro-dynamic and Nokoil (permanent magnet) speakers are described and list prices are given in Catalog No. 839 by Wright DeCoster, Inc., St. Paul, Minn.

New Products

Selenium Rectifier

A NEW LINE of industrial rectifiers, known as the Type SR series of Fansteel-I. T. & T. Selenium Rectifiers, has been announced by Fansteel Metallurgical Corp., North Chicago, Ill. These rectifiers employ selenium plates which operate similarly to other dry plate rectifiers, but a lesser number of plates and plates of a smaller size are required for a given voltage-current output. Efficiency is affected very little by temperature and therefore blowers or special cooling equipment are unnecessary. Age lowers the output only slightly, about five per cent in 10,000 hours and has no effect in the reverse current blocking direction. Selenium rectifiers will withstand overloads as high as 75 per cent for several hours

**NEW! TURNER 22X
CRYSTAL MICROPHONE**

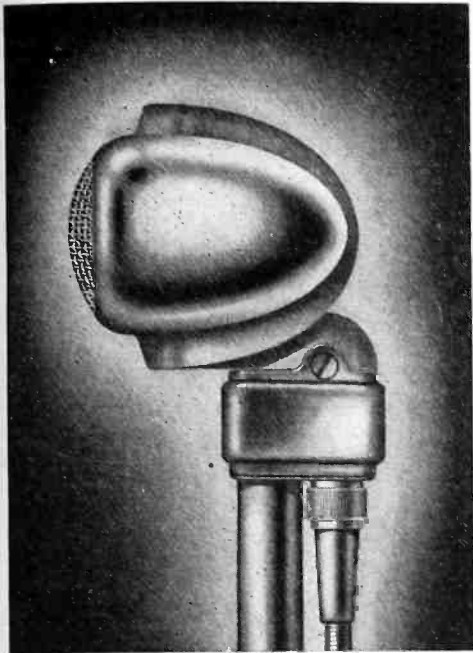

Powerful Sales and Profit Builder!

The attractive modern design, smooth response and high level output of the 22X offer unusual opportunities for sales and profits. Large capacity crystal permits long lines. Ideal for the Ham. Rugged enough for the toughest P.A. job. Removable cable set; full tilting head. Satin-chrome finish. Features equal to many \$25 units

\$16.50 List
With 7 Ft. Cable set

Range 30-7000 cycles
Level—52 D.B.

The TURNER CO.

Get Full Information 910 17th St. N.E.
CEDAR RAPIDS, IOWA

Licensed Under Patents of The Brush Development Co.

without deterioration. The power factor is practically unity, although this will vary according to the design of the associated transformer.

Photoelectric Control

A NEW PHOTOELECTRIC control, Model 150, is announced by United Cinephone Co., 43-37 Rawson St., Long Island City, N. Y. It operates on 110 volt, 60

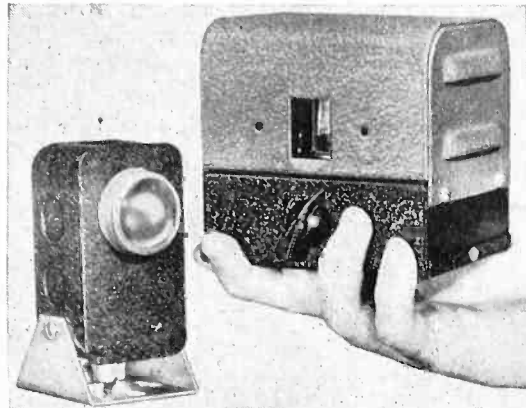

cycle power and contains a transformer to provide six volts for the light source. The power relay is designed for a non-inductive load of three amperes. A potentiometer adjustment permits compensation for various degrees of light intensity to the phototube. The net price is \$19.75.

Television Test Equipment

THREE NEW TELEVISION test instruments have been announced by RCA Manufacturing Co., Camden, N. J. They are a piezo-electric calibrator, Model 157, a five-inch wide-range oscillograph, Model 158, and a television alignment oscillator, Model 159. The alignment oscillator is for the visual alignment of the r-f and i-f circuits in television receivers. The calibrator is a small crystal oscillator having fundamental frequencies of 250 and 2000 kc. Harmonics of these frequencies are such as to provide exact calibrating frequencies for use in all high frequency work. Its accuracy is plus or minus 0.05 per cent. The five-inch oscillograph is useful for viewing synchronizing and blanking pulses, horizontal and vertical saw-tooth waves and grid and plate voltages on the horizontal and vertical oscillators.

Soldering Iron

A NEW SOLDERING iron (Catalog No. 400) especially designed for very light soldering is announced by Drake Elec-



tric Works, Inc., 3654-56 Lincoln Ave., Chicago. It measures eight inches overall, weighs eight ounces and is rated at 60 watts. It has a one-quarter inch tip.

High FREQUENCY



With RED•DOT Lifetime Guaranteed Instrument

VACUUM TUBE VOLTMETER

MODEL 1252 . . ONLY \$48.34 Dealer Net Price

MODEL 1252 is now furnished with RED•DOT lifetime guaranteed twin instrument, tilting type. One instrument indicates when bridge is in balance—the other is direct reading in peak volts. This vacuum tube voltmeter is self-calibrating with the additional advantages of the tube on the end of the cable. The initial operation of adjusting the bridge at the zero level insures exact calibration, independent of tube emission values, or when replacing tubes. Ranges are 3-15-75-300 volts. The ideal instrument for high frequency measurements.

Furnished in metal case, black suede enamel baked-on finish, etched panel silver and red on black, complete with tubes and accessories . . . \$48.34 Dealer Net Price

MODEL 1251

Self-Calibrating Vacuum Tube Voltmeter—the same as Model 1252 but with tube mounted inside the case . . . Dealer Net Price \$47.67

WRITE FOR CATALOG

Section 2310, Harmon Ave.

The Triplett Electrical Instrument Co.

Buffton, Ohio



**PLUGS — SOCKETS
TERMINAL PANELS, ETC.**



ILLUSTRATED
PLUG: P-6-CCT—SOCKET: S-6-AB

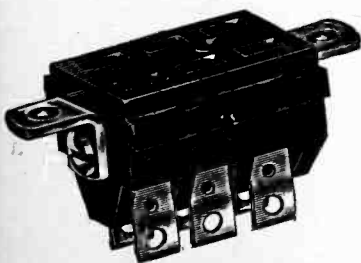

HUNDREDS OF STANDARD ITEMS OR SPECIALS TO YOUR BLUE-PRINTS.

WRITE FOR BULLETINS.

HOWARD B. JONES

2300 Wabansia Avenue
CHICAGO ILL.

D.C. studies through A.C. circuits

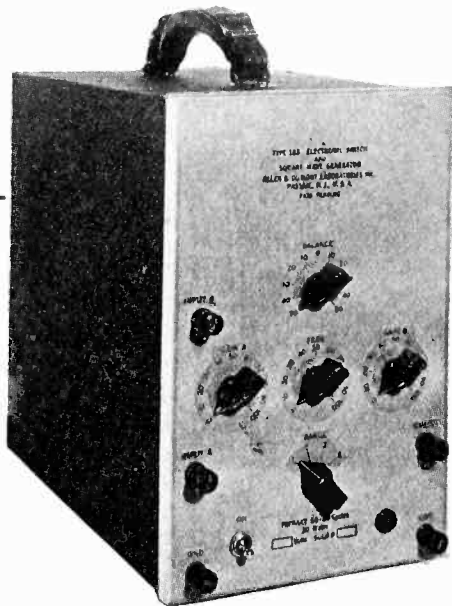

with the DU MONT ELECTRONIC SWITCH

- Because of the unique nature of the electronic switch circuit employed in the DuMont Type 185 Electronic Switch and Square-Wave Generator, it is possible to utilize this instrument to study direct-current signals with the conventional alternating-current amplifiers in standard cathode-ray oscillographs.

Used in conjunction with such instruments as DuMont Types 168, 175 or 175-A Cathode-Ray Oscillographs, this method may be employed for local or remote monitoring of modulated radio-frequency radiations at the detector of an ordinary radio receiver, and for the study of small direct-current signals such as bias potentials in vacuum-tube amplifiers.

Latest issue of *DuMont Oscillographer* contains detailed information on this application. A copy of this issue will be sent on request, together with descriptive literature on DuMont cathode-ray equipment.



PASSAIC

NEW JERSEY

Cable Address: Wespexlin, New York

Spectrophotometer

A NEW INSTRUMENT, the Regional Spectrophotometer, for the measurement of color absorption of liquids for each narrow region of the spectrum from the infra red to the ultra violet region is announced by Coleman Electric Co., Inc., 310 Madison St., Maywood, Ill. Extremely small impurities in a liquid may be detected by the variation in the characteristic absorption curve which can be plotted from the readings obtained from the Spectrophotometer. The concentration of liquids as evidenced by color absorption may be quickly and accurately determined. The range of the instrument being far beyond the visible spectrum, 350 to 1000 millimicrons, permits investigations of color absorption characteristics which heretofore have been almost impossible.

Stop Nuts

IT IS ANNOUNCED by Elastic Stop Nut Corp., 1015 Newark Ave., Elizabeth, N. J. that in addition to its standard line of self-locking nuts, these nuts are now available on order in any metal and in any combination of style, size and thread system. Elastic stop nuts incorporate a resilient non-metallic collar which takes up all the thread play, thus establishing a constant thread contact which holds the nut in position on the bolt regardless of vibration or wear of surrounding parts.

Aircraft Transmitter

A NEW AIRCRAFT transmitter has been announced by Collins Radio Co., Cedar Rapids, Iowa. It is the Type 17F-5 which contains the improved Autotune system of rapid frequency selection. A

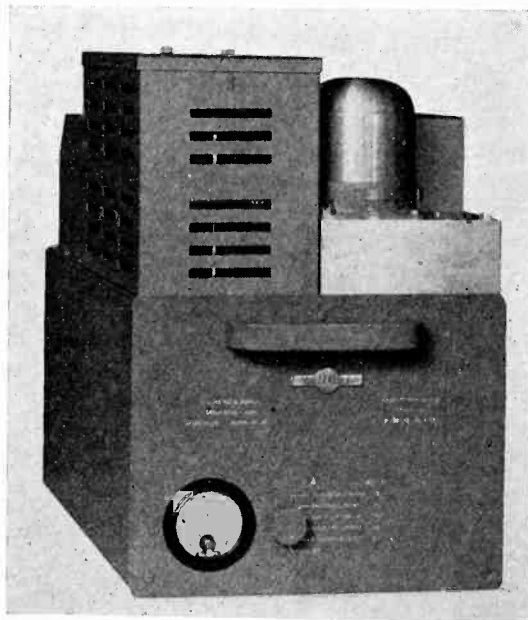

single set of condensers and variable coils is arranged for continuous tuning over the desired range. The tuning

operation is accomplished automatically within five seconds after the selector switch is set to the frequency desired. Another feature of this transmitter is the use of high level modulation of the output Class C r-f amplifier. Modulating voltage is obtained by an efficient Class B operated modulator stage, transformer coupled to plate and screen of the r-f final amplifier tube. This system requires no critical adjustment of output loading or r-f excitation values which might vary under operating conditions to produce distortion. The Type 813 tube used as the final amplifier requires no neutralization, thus assuring stable operation. This transmitter has been granted an approved type certificate by the Civil Aeronautical Authority.

Capacitors

A NEW TYPE of oil-filled filter capacitor for general transmitting use has been announced by Solar Manufacturing Corp., Bayonne, N. J. This unit, Solarex Type O is available in all stand-

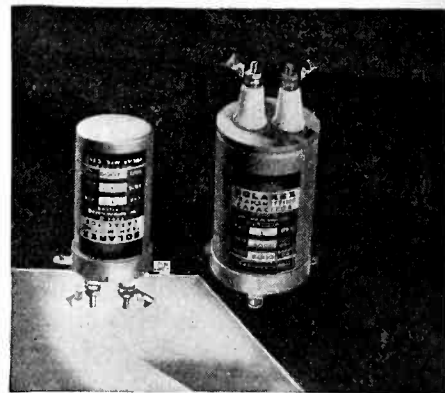

ard values and is built of paper sections which are oil-impregnated under high vacuum. The insulated assembly is rigidly held in a round metal can which is oil-filled and hermetically sealed. The terminals are on porcelain stand-off insulators and the units may be used in any position. Also announced by this company is the Type DY dry electrolytic capacitor. A new type of mounting is used with base prongs which fit chassis slots and are fastened by twisting.

Microphones

TWO MICROPHONES have been announced by The Brush Development Co., 3311 Perkins Ave., Cleveland, Ohio. Model QO has a frequency range from 30 to 9,000 cps and an output level of minus 54 db. It is not responsive to wind disturbances and therefore is suitable for many outdoor uses. Model US was developed to meet the demand for a sensitive microphone in the inexpensive field. It has an output level of minus 44 db and has good fidelity. It is designed especially for mobile transmitters and for communications work. Also announced by this company

are Type BJ headphones. A soft rubber jacket encasing the cartridge assures ruggedness, comfort, good ear seal and safety from shock. A hermetically sealed aluminum cartridge construction protects the phones against adverse climatic conditions.

Condenser

THE NEW Type 755-A Variable Air Condenser announced by General Radio Co., 30 State St., Cambridge, Mass., is designed for use in high- and ultra-high-frequency circuits. A precision worm drive with 30 to 1 reduc-

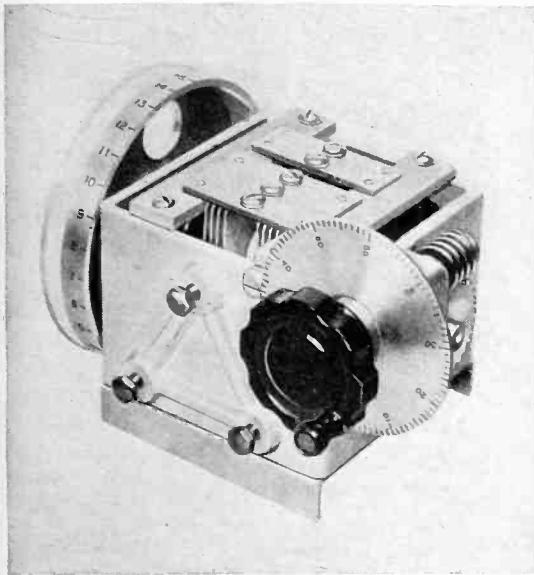

tion drives the rotor plates. Backlash is practically eliminated through the use of a spiral spring on the main shaft. Both the rotor and stator plates are of soldered brass, heavily copper plated. The plates are shaped to spread out the frequency scale. Both rotor and stator are insulated from the frame. The range of direct capacitance is 5 μmf to 142 μmf . Rotor-to-ground capacitance is 7 μmf and stator-to-ground capacitance is 6 μmf . The equivalent series inductance is approximately 0.0055 μh at minimum capacitance setting. This condenser can be used in conjunction with a coil switching system at frequencies as high as 350 Mc.

Transmitting Tube

A NEW FILAMENT type beam power transmitting tube, the HY69 to replace the HY61 (identical with the 807), has been announced by Hytronic Laboratories, 76 Lafayette St., Salem, Mass. It is designed for communication work where the operating period is but a fraction of the total time and therefore the thoriated tungsten filament heats to operating temperature almost instantaneously. The Type HY69 has a plate dissipation of 40 watts as compared with 25 watts of the Type HY61. This tube fits well into police radio, air-craft radio, marine radio, forestry service and other applications where radio is used in short-distance communications.

Astatic Meets Increasing Demand with New, Crystal Recording Head

Model X-26 is designed for use in recording an acetate coated blank, but may also be used on wax master plates. Due to the constant amplitude characteristic, higher volume levels can be recorded without groove crossover. By changing values in the matching circuit, the frequency response may be modified to suit any condition. Astatic 33-C Recording Head Equalizer will answer all average recording requirements. Astatic T-26 Transformer provides a convenient available means for matching the X-26 Recording Head and input network to low impedance lines.

X-26—Recording Head.....	List Price \$30.00
T-26—Matching Transformer.....	List Price \$7.00
33-C—Recording Equalizer.....	List Price \$2.50

ASTATIC

ASTATIC MICROPHONE LABORATORY, Inc.

YOUNGSTOWN, OHIO

Astatic Crystal Products Licensed Under Brush Development Co. Patents

ACCURACY $\pm 2\%$

for this NEW

50 WATT

OUTPUT POWER METER

TYPE OP-961*

- ★ Provides direct reading of POWER or Db. LEVEL from 0.1 mw. to 50 watts.
- ★ Load impedance range 2.5 to 20,000 ohms; 40 steps.
- ★ Frequency range 30 to 10,000 cycles.
- ★ Accuracy $\pm 2\%$ at midscale meter reading.

\$110

Write for further details

*PATENTED

THE DAVEN COMPANY

158 SUMMIT STREET
NEWARK, NEW JERSEY

CONTACTS

FOR THE FIELD OF ELECTRONICS

We manufacture a complete line of equipment

SPOT WELDERS, electric, from 1/4 to 500 KVA
 TRANSFORMERS, special and standard types
 INCANDESCENT LAMP manufacturing equipment
 RADIO TUBES, ex-ray, cathode ray, photo cells
 ELECTRONIC EQUIPMENT, vacuum pumps, etc.
 TUNGSTEN SLUGS, rod and wire manufacturing equipment
 GENERAL GLASS working machines and burners
 COLLEGE GLASS working units for students and laboratory

EISLER ENGINEERING COMPANY, CHAS. EISLER, Pres.
 751 So. 13th St. (near Avon Ave.) Newark, New Jersey

Please reply Attention: Chas. Eisler, President

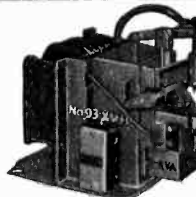

B-L RECTIFIERS

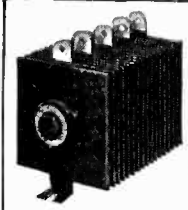

CHANGE AC TO DC WITHOUT MOVING PARTS, GLASS BULBS, LIQUIDS, OR SPARKING CONTACTS.

DRY—DURABLE
 COMPACT—ECONOMICAL
 SPECIAL RECTIFIERS AND COMPLETE ASSEMBLIES

THE BENWOOD LINZE CO.
 ST. LOUIS, MO.
 ELECTRICAL RECTIFIERS ENGINEERS
 MANUFACTURERS

NEW EICOR XT DYNAMOTORS

5200 Series...Output 200 Watts
 6100 Series...Output 500 Watts

Write for Information Today

★ **EICOR INC.** ★
 517 S. Lavin St., Chicago, U. S. A.

VACUUM TUBES AND ELECTRONIC DEVICES

Industrial control and circuit problems. Design, Development and Construction of tubes and circuits.

VACUTRON, INC.
 20 West 22 St. New York, N. Y.

FINE RIBBONS

of Tungsten, Molybdenum and Special Alloys

To your specifications

H. CROSS
 15 BEEKMAN ST. NEW YORK

ELECTRON TUBE PARTS

QUALITY All Types EST. 18 YEARS

Seal Finish Tungsten Welds
 Tungar Welds Coil Springs
 Filament Hooks Bases
 Spot Welders Caps
 Stem Wire Cutting & Forming Machines

"The Engineering Co." of Newark, N. J., Inc.
 Daniel Kondakjian, Pres.
 59 Branford Street Newark, N. J.

MICROMETER

for checking transmitters.
 from 1.5 to 56 mc.
 within 0.01 per cent.

LAMPKIN LABORATORIES
 — Bradenton, Fla., U. S. A. —

ACTONE Shadowgraphed Needles

give true reproduction because they form-fit record grooves. Protect expensive recordings. Use Actone shadowgraphed perfect point needles for all reproductions.

Write for Samples
H. W. ACTON CO., Inc., 370 7th Ave., New York

Oscillator

A RESISTANCE TUNED audio frequency oscillator has recently been announced by Hewlett-Packard Co., 367 Addison Ave., Palo Alto, Calif. A continuously

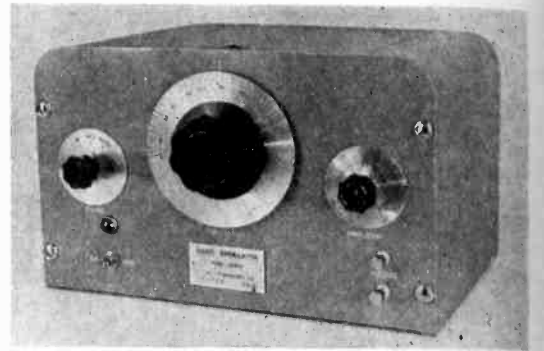

variable frequency range is provided by means of a resistance capacity network. The thermal drift is negligible. A balancing circuit is used so that the distortion over the frequency range from 20 to 35,000 cps is less than one per cent. Four standard models are available with one watt output in either cabinet or relay rack mounting. This company will supply oscillators for special purposes using the resistance tuned principle.

Indicating Device

A REMOTE CONTROL motor or indicating device operating similarly to the Selsyn motor has been announced by Elsbert Manufacturing Co., 353 West Grand Ave., Chicago. It is controlled

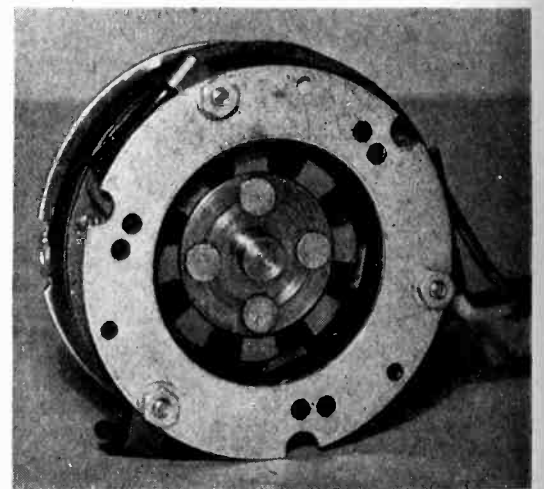

as to direction and amount of motion by an external switch. For each change of a switch contact, the motor unit makes 1/24 of a revolution in a direction according to the direction of motion of the switch. The motor has six field poles with opposite poles connected in series. The rotor consists of eight laminated poles with no windings. The three sets of field poles are connected to the first three contacts on the switch controlling the motion. Further motion is obtained by connecting the field poles, in order, to the remaining switch contacts. The unit is approximately 2 3/4 inches in diameter and it consumes 7 1/2 watts. The preferable voltage is 12 to 24 volts ac.

"What Can It Do For Me?"

Advertising that is read with this thought in mind, may provide the solution to a problem that has kept you awake nights for weeks. Remember, back of the signature of every Electronics advertiser is another organization, whose members have thought long and hard about your business in the course of introducing and applying their products or services to your industry. If their offerings can improve the quality of your company's product . . . or save your company's money . . . they can contribute to your company's income. We all know, "It pays to advertise." It pays just as big to investigate what is advertised! Each month, Electronics advertisers, old and new, invite you and over 13,600 other subscribers to investigate further the advantages they can provide.

Departmental Staff ELECTRONICS

Meter

A UNIVERSAL METER in which the operator is protected against accidental contact with high voltages is announced by The Clough-Brengle Co., 5501 Broadway, Chicago. It is the No.



220 Unimeter in which special high voltage terminals are provided. Seven ranges are provided for both ac and dc voltages. The direct current scales range from 50 microvolts to 20 amperes. There are also resistance and decibel scales. Also announced by this company is the No. 230 A-C Bridge for the measurement of condensers. The range is from 2 μf to 200 μf .

D-c voltages can be applied to condensers during measurements to insure correct readings of capacity and power factor under conditions of actual use.

Power Outlet

A COMPACT POWER outlet which can be riveted to the chassis of a radio set with the same size rivets as the sockets and other parts is announced by Alden Products Co., 715 Center St., Brockton, Mass. The design was prompted by the fact that conventional outlets are too large for chassis mounting and do not fit into production line methods of assembly. The new outlet is rated at 15 amperes, 125 volts and 10 amperes, 250 volts. It is supplied with either contact terminals or lead wires.

Signal Generator

A SIGNAL GENERATOR, Series E-200, which features the a-v-c substitution method for simplified, accurate radio receiver alignment is announced by Precision Apparatus Co., 647 Kent Ave., Brooklyn, N. Y. It has six bands from 110 kc to 72 Mc and is direct reading on all bands. The maximum deviation is one per cent on all bands under widely varying climatic conditions. An independently controlled 400-cps oscillator is included and the r-f signal may be modulated from zero to 100 per cent.

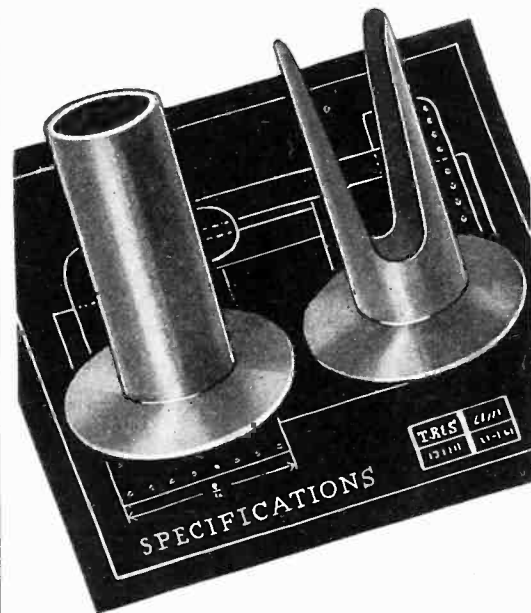

Make T R & S Rivets Standard for Complete Satisfaction

In specifying rivets for your job, it is important to get the best. That's why you should insist upon T R & S rivets. T R & S quality means every rivet is of uniform preciseness, accurately gauged to drive smoothly and with non-brittle efficiency.

Insure complete satisfaction by making T R & S rivets the standard specification. We have solved the riveting problems of America's leading industrial concerns.

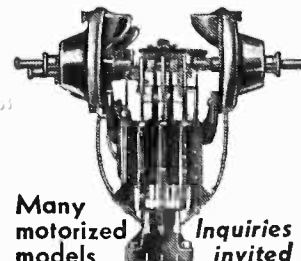

Many motorized models available in single stroke and multiple drive. Inquiries invited with samples of work you wish to do.

TUBULAR RIVET & STUD CO.

World's Foremost Producers of Rivets
Wollaston Massachusetts



Just Out!

RADIO SERVICE TRADE KINKS

By LEWIS S. SIMON, Manager, Rexall Radio Stores, Brooklyn, N. Y. 269 pages, 9 x 11, spiral-bound to open flat, \$3.00

- A quick-reference manual of radio set troubles and their repair
- Saves time in testing and troubleshooting—shows weaknesses and key trouble spots of specific sets
- Gives practical methods of repair and adjustment taken from successful radio servicing experience
- Covers hundreds of makes and models of radio receivers, household and auto

Make more money on your radio servicing jobs—

This is one service manual it will pay you to use. You will step up your profits on servicing jobs from the day you put the book to work for you. Every line in it has come out of actual, shirt-sleeve practice. This is no theory book.

This manual gives you blunt, step-by-step directions for finding troubles and for fixing them. Some of the methods are homely trade kinks that have never before been known except to a few expert service men. The book will save you hours of time and will give you satisfied customers.

It points out the weak points of radio receivers of specific makes and models, and consequently enables you to go right to that point to spot the trouble. It saves you going through elaborate tests of the entire circuit.

Every trouble solution in the book has been checked and re-checked again and again. Every page of directions may be depended upon.

Try the book out on your next servicing call. We are anxious to send you a copy on approval for 10 days' examination just for that purpose. Fill in and send the coupon today.

McGraw-Hill ON-APPROVAL COUPON

McGraw-Hill Book Co., 330 W. 42nd St., N. Y. C.
Send me Simon's Radio Service Trade Kinks for 10 days' examination on approval. In 10 days I will send \$3.00 plus few cents postage, or return book postpaid. (Postage paid on orders accompanied by remittance.)

Name

Address

City and State

Position

Company L-10-39
(Books sent on approval in U.S. and Canada only.)



Frequency Measuring Service



Many stations find this exact measuring service of great value for routine observation of transmitter performance and for accurately calibrating their own monitors.

MEASUREMENTS WHEN YOU NEED THEM MOST
at any hour every day in the year

R.C.A. COMMUNICATIONS, Inc.

Commercial Dept.

A RADIO CORPORATION OF AMERICA SERVICE

66 BROAD STREET

NEW YORK, N. Y.



PERMANENT MAGNETS

ALL SHAPES — ALL SIZES
FOR ALL PURPOSES

Stamped, Formed, and Cast; Chrome, Tungsten, Cobalt and **ALNICO**** (cast or sintered) under G. E. license.

THOMAS & SKINNER
STEEL PRODUCTS COMPANY

1116 E. 23rd STREET INDIANAPOLIS, INDIANA

Laminations for Radio Transformers — Tools
Dies — Heat Treating — Stampings

38 YEARS EXPERIENCE

I.R.E. Convention

(Continued from page 17)

oscilloscopes. Marking on the alignment circuits is performed by absorption circuits for frequencies other than carrier frequencies. The carrier frequencies are marked by an oscillation generated at an off-carrier point by heterodyning a crystal oscillator with the sweep oscillator, the beat note being cut into the circuit at the time the sweep passes the carrier position.

Aircraft Navigation Equipment

Two papers suggested methods whereby radio guidance can be made a more effective aid to air navigation. The paper by C. W. Carnahan was particularly concerned with the use of cathode-ray tube indicators for showing the position of a plane relative to a beacon station. The author suggested the use of a frequency modulated wave for producing a signal having a definite characteristic at all points of the compass, so that the true direction

SEARCHLIGHT SECTION

EMPLOYMENT : BUSINESS : OPPORTUNITIES : EQUIPMENT — USED or RESALE

UNDISPLAYED RATE:

10 cents a word, minimum charge \$2.00.

Position Wanted: (full or part-time salaried employment only), 1/2 the above rates, payable in advance.

Proposals, 40 cents a line an insertion.

INFORMATION:

Box Numbers in care of our New York, Chicago, or San Francisco offices count 10 words additional in undisplayed ads. Replies forwarded without extra charge.

Discount of 10% if full payment is made in advance for four consecutive insertions of undisplayed ads (not including proposals).

DISPLAYED—RATE PER INCH:

The advertising rate is \$6.00 per inch for all advertising appearing on other than a contract basis. Contract rates quoted on request.

An advertising inch is measured 1/8" vertically on one column, 3 columns—30 inches—to a page.

Copy for new advertisements must be received by October 31st for the November issue

POSITIONS VACANT

ELECTRICAL ENGINEER WANTED by Transformer Manufacturer, must be capable designing radio type transformers, estimate costs, supervise production etc. Robert M. Hadley Co., P.O. Box 456, Newark, Delaware.

POSITIONS WANTED

LICENSED RADIO TELEPHONE OPERATOR, first class, technical graduate, six years experience control room work, nemo, recording, network feeds. Now employed. Desires opening offering opportunity for advancement. PW-219, Electronics, 330 W. 42nd St., New York, N. Y.

FACTORY MANAGER. PRODUCTION MANAGER. Successful large scale electrical, mechanical, novelties, sheet metal products experience. Planning, methods, time study, piece work. Cost reduction, labor-material. Inventory control, cost estimates, skilled labor relations. Design, development new products. Steam, electric, vacuum, hydraulic equipment. Bakelite molding. Machine shop, maintenance, engineering, purchasing. Complete management. Moderate salary. Location unimportant. PW-220, Electronics, 330 W. 42nd St., New York, N. Y.

POSITIONS WANTED

RADIO ENGINEER: age 30, graduate in Electrical and Radio Engineering. 1st class telephone and telegraph licenses. Eight years experience in broadcast and commercial operations. Desires position with broadcast station. PW-221, Electronics, 330 W. 42nd St., New York, N. Y.

FOR SALE

STANDS for all types of microphones; Standard or special floor and desk models. Expert repairs Velocity and Carbon microphones. Ellis Laboratory, 189-R W. Madison St., Chicago, Ill.

PATENT ATTORNEY

PATENTS—Personal attention ensures satisfactory results — Application, searches, negotiations—Thad R. Goldsborough, Patent Attorney, 2714 Quarry Road, Northwest—Washington, D. C.

DEPENDABLE

Used

ELECTRONIC TUBE EQUIPMENT

A complete line of used equipment for the manufacture of Radio Tubes, Neon Tubes, Incandescent Lamps, etc.

Write for Bulletin showing savings from 25 to 75%

EISLER ELECTRIC CORP.
534 39th Street, Union City, N. J.

3-STAGE HIGH VACUUM PUMP

G.E. Type York Model

Original Cost \$350.00

Now selling for \$45.00

Good running condition

EISLER ENGINEERING CO., Chas. Eisler, Pres.

751 So. 13 St. (near Avon Ave.) Newark, N. J.

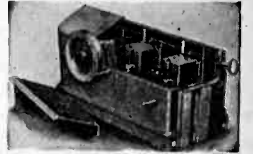

HIGH GRADE USED

ELECTRON TUBE MACHINERY

Huge Stock of Every Type and Variety

KAHLE ENGINEERING CORPORATION

Specialists in Equipment for the Manufacture of Neon Tubes, Radio Tubes, Incandescent Lamps, Photo Cells, X-ray Tubes, etc.

900 DeMott St., North Bergen, N. J.

Mention of
Searchlight Section of
ELECTRONICS

will be appreciated by the
advertisers and the publishers

need relays ?

Jack, target, potential, oil dash pot, thermal time delay and indicator types. In fact, all types for all purposes are made by Autocall, specialists for over 30 years in signalling and control devices and equipment.

INDICATOR TYPE

RI-10

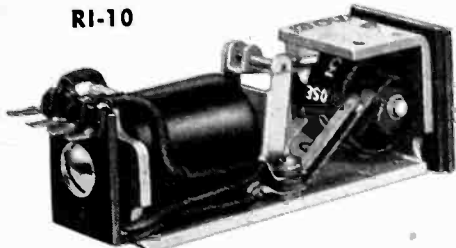

Eleven position rotary indicator. High speed. Indicator can be numbered, lettered or consist of colored bars, etc., as required.

Write today for NEW CATALOG

The Autocall Co.
SHELBY . . . OHIO

- RELAYS
- INDICATING DEVICES
- BELLS, HORNS, CHIMES and MISC. EQUIPMENT
- TERMINAL DISCONNECT BLOCKS
- ANNUNCIATORS
- LIQUID FLOW DEVICES
- CODING TRANSMITTERS
- SIGNALLING SYSTEMS - ALL TYPES

Model CR-6-A BEAT FREQUENCY STANDARD SIGNAL GENERATOR



The model CR-6-A beat frequency standard signal generator supplies a reliable signal of known potential and frequency over the wide ranges of from 10 micro volts to 100 volts any where in the range from 10 cycles per second to 50 kilocycles per second.

Over eight years of experience and two years of design and research contributed to making this instrument available at such a reasonable price.

The JONES-ORME Engineers are experienced in the design of special audio frequency equipment. Write us about your special problems, we will be glad to quote on special equipment.

Write for circular or model CR-6-A beat frequency standard signal generator and other Jones instruments.

JONES-ORME Company
2233 University Avenue
St. Paul, Minnesota

of the plane from the beacon could always be known continuously. The paper immediately following, by E. N. Dingley Jr., of the Navy Department, was by an unusual coincidence on precisely the same topic, and in fact went into considerable detail on a frequency-modulated system for an omni-directional beacon devised by the author. The basic arrangement is shown in the figure. A single frequency-modulated transmitter feeds three radiators, one directly, the other two through delay transmission lines. The delay introduced by the transmission lines is sufficiently long, relative to the variation in frequency, so that the signals radiated from the antennas are always different in frequency. Furthermore, the relative distance of the plane from any two of the radiators introduces a further differential delay, which further alters the frequency difference between the two received waves, and which does so according to the azimuthal position of the plane.

Generation of Ultra-High Frequencies

Two papers on the ever-important topic of generating and controlling power at ultra-high frequencies. A. V. Haeff and L. S. Nergaard of RCA Radiotron described the present version of the inductive-output beam-type power amplifier (described in *Electronics*, February, 1939, page 30).

About 10 watts have been generated at 500 Mc at power gain of 10 into a circuit loaded for flat response over a band of 10 Mc.

A more conventional approach to high power on the ultra-highs was revealed in three papers on "Development of a 20-kilowatt ultra-high-frequency tetrode for Television Service" by Messrs. Haeff, Wagner, Zottu, Ayer, and Gihring of RCA Radiotron. The tetrode construction was chosen because the small grid-plate capacitance of the design obviated the necessity of neutralizing (difficult from a mechanical point of view on the u-h-f service) and decreased the number of possible parasitic oscillations. A power output of 56 kilowatts in two tubes, at an efficiency of greater than 50 per cent has been produced experimentally on frequencies in the neighborhood of 100 Mc.

TYPE 892 SIX POSITION BAND SWITCH

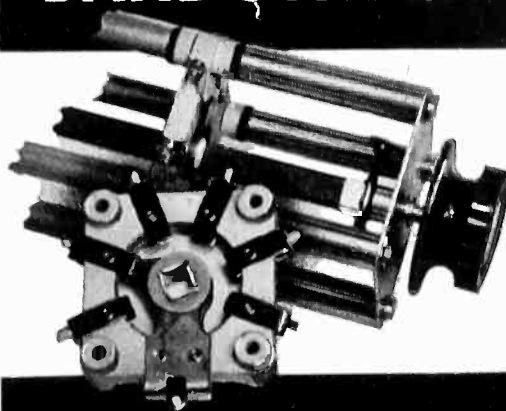

- Will Handle 1 kw Power
- Versatile Application
- Nickel Silver Contacts
- Alsimag Insulation
- Low Loss—Reliable
- Rating at 1 mc:
15 Amps. 4000 Volts

WRITE FOR DATA

HEINTZ AND KAUFMAN
SOUTH SAN FRANCISCO LTD. CALIFORNIA U.S.A.

Headquarters for SOUND EQUIPMENT

LAFAYETTE

Sound engineers come direct to Lafayette for their P.A. requirements because Lafayette has everything in P.A. It saves valuable time . . . saves money, too! The Lafayette "packaged" line for 1940 is complete—boasts a sound system for every purpose, each engineered for greater performance and dependability. Lafayette stocks are also complete. There's no waiting, no running around for necessary component parts. Buying direct, of course, means lower prices for quality sound equipment. So, do as prominent sound engineers do—come to headquarters for your P.A.—and take advantage of Lafayette service and economy. Mail the coupon for FREE Lafayette catalog with the big P.A. section.

NEW YORK, N.Y. • CHICAGO, ILL. • ATLANTA, GA.
100 SIXTH AVENUE • 101 W. JACKSON BLDG. • 245 PEACHTREE ST.
BOSTON, MASS. • BRONX, N.Y. • NEWARK, N. J. • JAMAICA, L. I.

LAFAYETTE PUBLIC ADDRESS EQUIPMENT

Radio Wire Television Inc.
Dept. 14KP9—100 Sixth Ave., New York, N. Y.
Rush FREE 1940 Radio Catalog No. 78

NAME.....
ADDRESS.....
CITY..... STATE.....
PASTE COUPON ON PENNY POSTCARD

DUAL-Point MICRODYNE



THE new AUDAX Jewel-point MICRODYNE not only in-sures flat response to well over 8,000 cycles . . . but saves the untold delay, expense and annoyance of sending your pick-up back to the factory should an accident damage the jewel itself.

Thanks to an ingenious feature—essentially and exclusively AUDAX—even while waiting for a new JEWEL, you can keep the MICRODYNE going by using conventional steel needles—and still be sure of consistent hi-fidelity performance.

This important advantage has scored heavily among technicians who formerly were afraid to employ a jewel-point . . . once more strengthening the AUDAX reputation:

**"The Standard
By Which Others Are
Judged and Valued"**

Twenty-odd years of rich experience in helping sound reproduction to higher planes of performance! What wonder that today our Magneto-Inductive principle is standard with leading engineers in the world's foremost Broadcasting Stations, Laboratories . . . in fact, wherever the highest quality performance is paramount.

MICRODYNE—regardless of climatic conditions—delivers consistently uniform response with the sharp, clean-cut definition of the finest Magneto-Inductive Pick-up . . . yet for all its superlative quality, **COSTS NO MORE THAN THE ORDINARY PICK-UP.**

LIST PRICES START AT

\$12.50

WRITE FOR OUR LATEST LITERATURE

AUDAK COMPANY
500 Fifth Ave., New York City

"Creators of High Grade Electrical and Acoustical Apparatus since 1915"

INDEX TO ADVERTISERS

Acme Electric & Mfg. Co.	61
Acton Co., Inc., H. W.	68
American Automatic Electric Sales Co.	50
American Screw Co.	Back Cover
Amperex Electronic Products, Inc.	Second Cover
Astatic Microphone Laboratory, Inc.	67
Atlas Sound Corp.	57
Audak Company	72
Autocall Co.	71
Bakelite Corp.	7
Benwood-Linze Co.	68
Biddle Co., James G.	54
Bliley Electric Co.	57
Callite Products Division	64
Cannon Elec. Development Co.	56
Carter Motor Co.	54
Centralab Div., Globe-Union, Inc.	2
Chandler Products Co.	Back Cover
Cinaudagraph Corp.	51
Cinch Manufacturing Co.	35
Continental-Diamond Fibre Co.	53
Continental Screw Co.	Back Cover
Corbin Screw Corp.	Back Cover
Cornell-Dubilier Elec. Corp.	6
Cross, H.	68
Daven Co.	67
Distillation Products, Inc.	59
Driver Co., Wilbur B.	62
Du Mont Laboratories, Inc., Allen B.	66
Eicor, Inc.	68
Eisler Engineering Co.	68
Eitel-McCullough, Inc.	47
Engineering Co. of Newark, N. J., The	68
Erie Resistor Corp.	39
Fairchild Aerial Camera Corp.	49
Ferranti Electric, Inc.	Third Cover
Goat Radio Tube Parts, Inc.	50
Guardian Electric Mfg. Co.	63
Heintz & Kaufman, Ltd.	71
Hytronic Laboratories: Division of Hytron Corp.	55
Jones, Howard B.	65
Jones-Orme Co.	71
Kurman Electric Co.	64
Lampkin Laboratories	68
Lamson & Sessions Co.	Back Cover
Lapp Insulator Co.	3
Leach Relay Co.	55
Lingo & Son, Inc., John E.	61
Mallory & Sons, P. R.	8
McGraw-Hill Book Co., Inc.	69
Millen Mfg. Co., Inc., James	61
National Screw & Mfg. Co.	Back Cover
Ohmite Mfg. Co.	46
Parker-Kalon Corp.	Back Cover
Pheoll Mfg. Co.	Back Cover
Phillips Screws	Back Cover
Pioneer Gen-E-Motor Corp.	58
Radio City Products Co.	62
Radio Wire Television Inc.	71, 72
RCA Communications, Inc.	70
Raytheon Mfg. Co.	58
Remler Co., Ltd.	63
Richardson Co.	44
Roller-Smith Co.	57
Russell, Birdsall & Ward Bolt & Nut Co.	Back Cover
Scovil Mfg. Co.	Back Cover
Shakeproof Lock Washer Co.	Back Cover
Sigma Instruments, Inc.	72
Superior Tube Co.	4
Synthane Corp.	41
Thomas & Skinner Steel Pds. Co.	70
Triplett Electrical Instrument Co.	65
Tubular Rivet & Stud Co.	69
Turner Co.	65
United Transformer Corp.	48
University Laboratories	63
Vacutron, Inc.	68
Ward Leonard Electric Corp.	59
Webster Electric Co.	64
Western Electric Co.	5
Westinghouse Electric & Mfg. Co.	36, 37
Weston Electrical Instrument Corp.	43
White Dental Mfg. Co., S. S.	56
Zophar Mills, Inc.	54
Professional Services	62
SEARCHLIGHT SECTION (Classified Advertising)	
EMPLOYMENT	70
EQUIPMENT FOR SALE	
Eisler Electric Corp.	70
Eisler Engineering Co.	70
Kahle Engineering Corp.	70



for

SENSITIVITY

D.C. RELAYS

operating at one to fifty milliwatts to control A.C. loads of 50 to 1000 watts

A.F. RELAYS

actuated by telephonically applied sound to initiate control functions through other relays

ACOUSTIC SWITCHES

with sensitivity adjustable for desired response to sounds of high or low intensity.

Write for Data Sheet Number Seven listing new Sigma products including the type 3-U one milliwatt relay.

Sigma Instruments, Inc.

388 Trapelo Road
Belmont Massachusetts



**put your foot down
AND YOUR FEET UP**

Resolve right now that you're through chasing around in search of the equipment you need. You're going to relax, put your feet up, order everything from the Lafayette radio catalog—and save your energy, and money. It's not only the smart way to buy today in radio—you can't beat our 24 hour delivery service; it's the *thriftiest* way to buy. For you can't beat our prices. Send for copy of Radio's buy-word book for 1940. It's **FREE.**

Radio Wire Television Inc.
formerly WHOLESALE RADIO SERVICE CO., INC.

LAFAYETTE RADIO

NEW YORK CHICAGO ATLANTA
100 Sixth Avenue 901 W. Jackson Blvd. 265 Peachtree St.
BOSTON NEWARK JAMAICA L. I. BRONX, N. Y.
110 Federal St. 24 Central Ave. 90-08 166th St. 542 E. Fordham Rd.